

SCIENCE IN A TOPIC

# COMMUNICATION

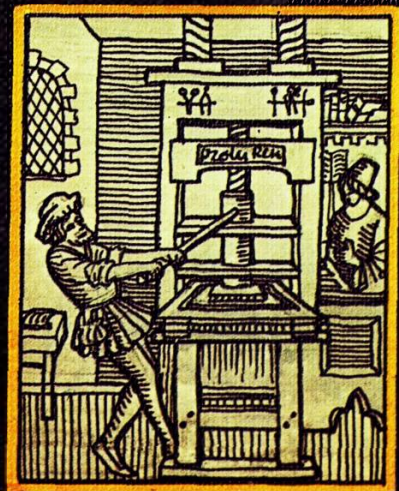
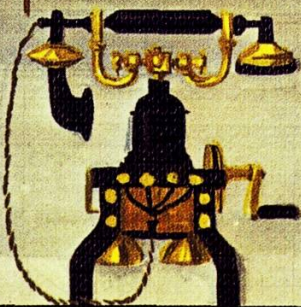
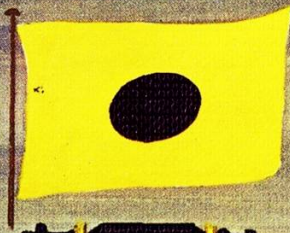
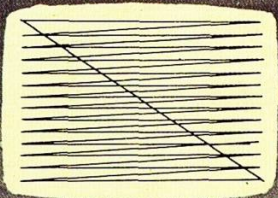
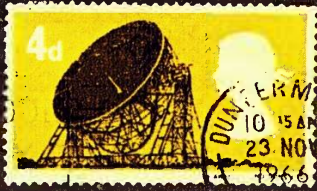

Doug Kincaid  
Peter S. Coles  
**HULTON**

# Model Making – a 'clacker' and 'receiver'

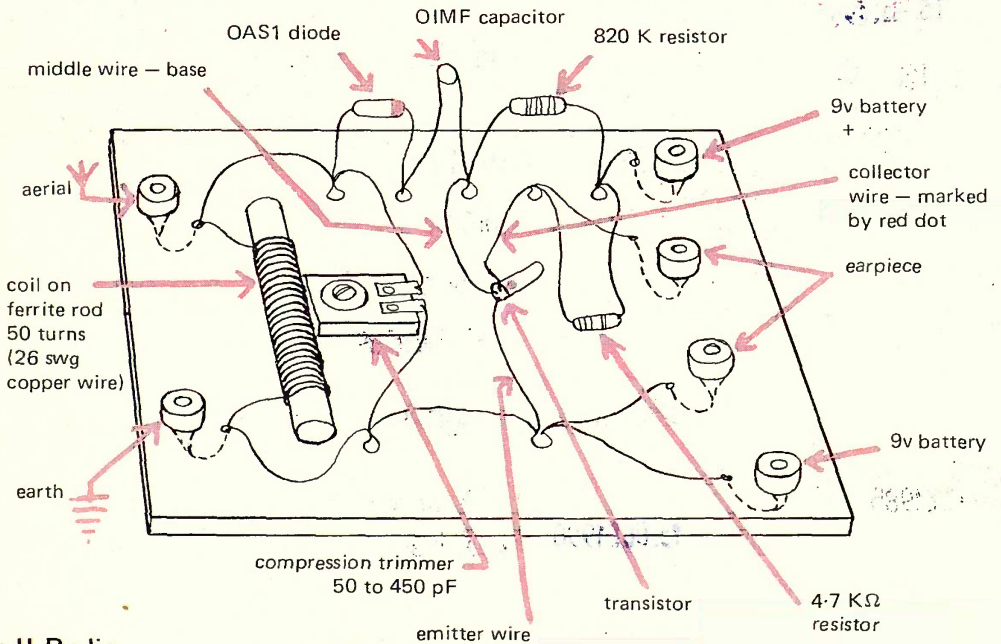
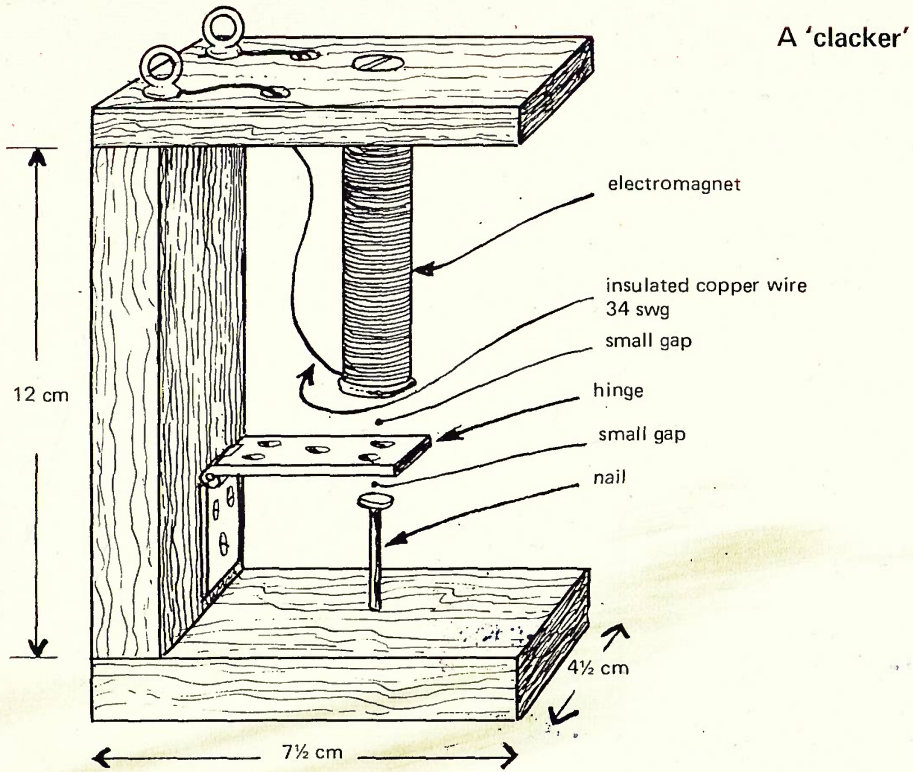

A Mark II Radio

A good easy way to build this type of simple radio is to use Philip's Radio and Electronic Kit – X40

wpj3

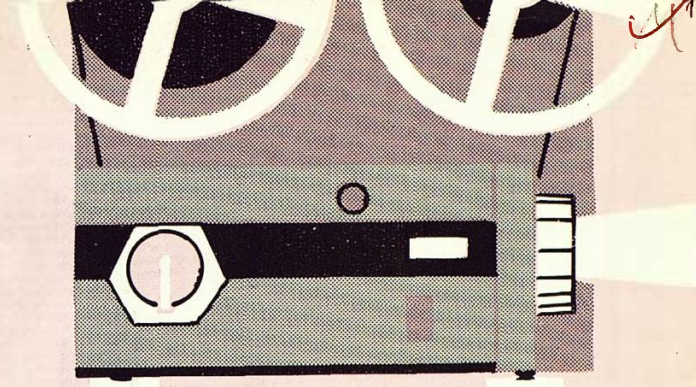
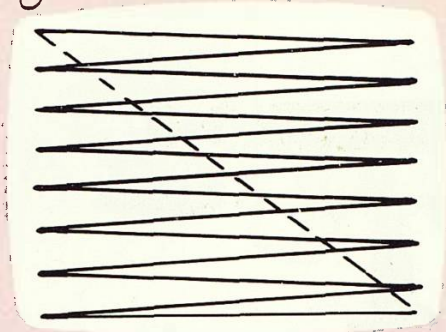

Science in a topic

# COMMUNICATION

by DOUG KINCAID  
PETER S. COLES

Illustrated by Chris Hoggett

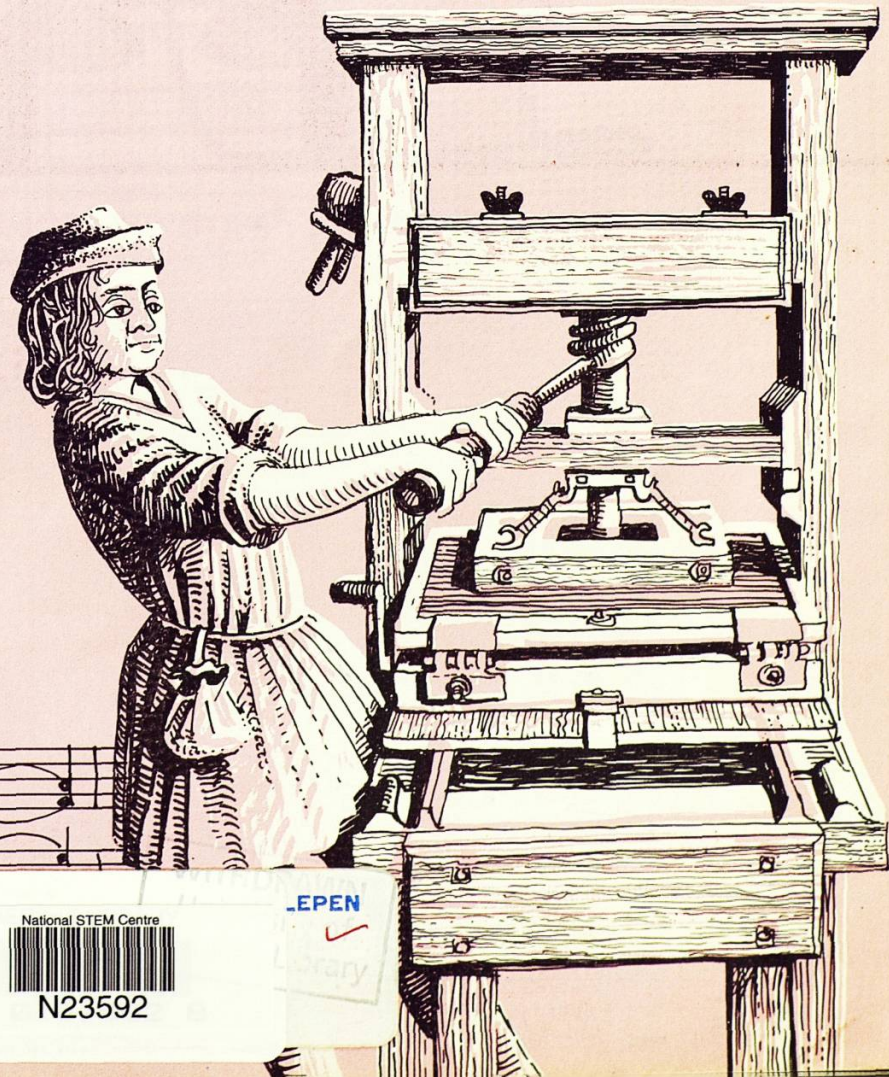

HULT

National STEM Centre



N23592

EPEN



Library

A B C D E F G H I J K L M N O P Q R

A B C D  
4 9 7 A

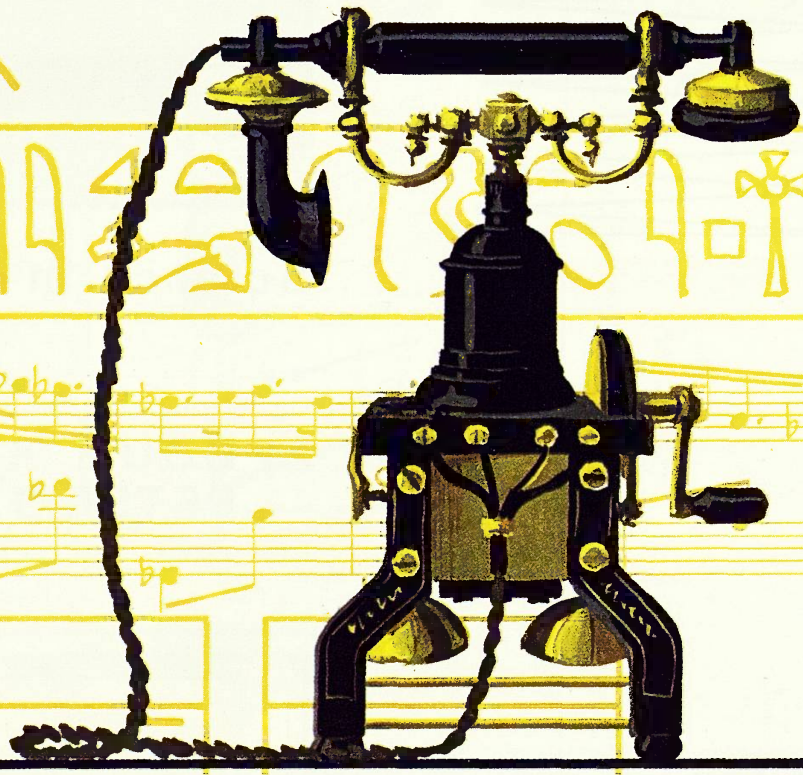
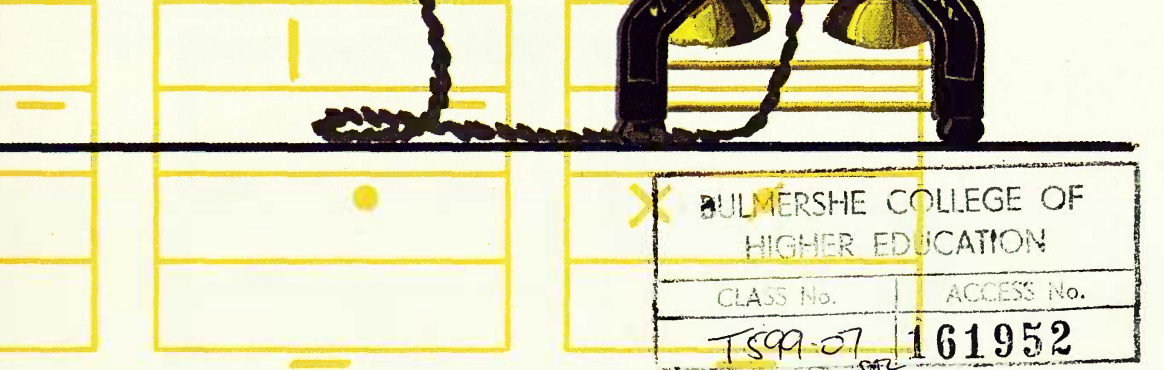

X BULMERSHE COLLEGE OF HIGHER EDUCATION	
CLASS No.	ACCESS No.
TS99-07	161952

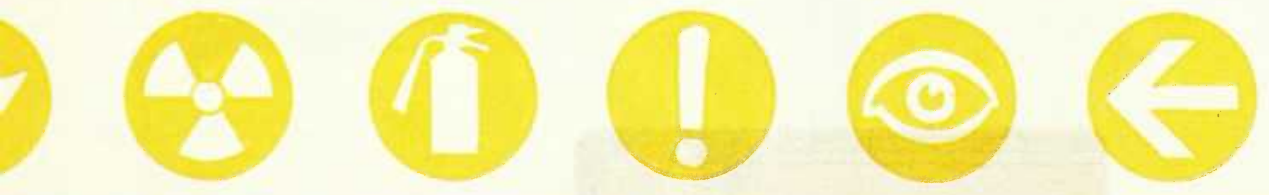
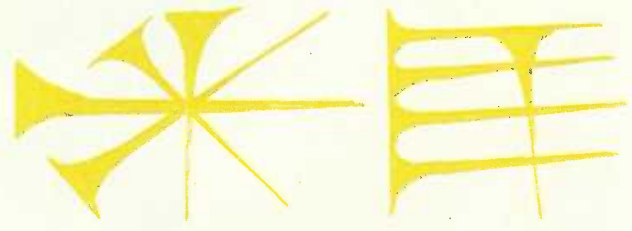
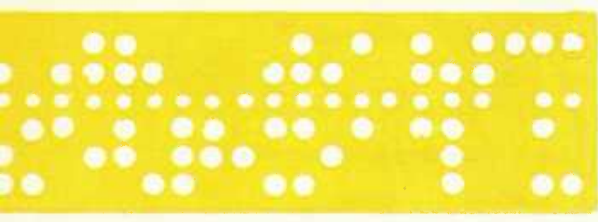

# SCIENCE IN A TOPIC COMMUNICATION



## About this book

This book is different from most others because:

- 1 It is not complete, but only part of a study — the science part. There will be a need to use many other books to find out about other aspects of the topic — History, Geography . . .
- 2 It will not tell you information but will only ask you questions and suggest ways that you might find the answers for yourself. Many of the suggestions were some children's ways of trying to find an answer — you may have better ideas.
- 3 It is hoped that arising from these questions other questions will occur to you — do pursue these. (Your own questions and the ways you find to answer them are really the most important.)
- 4 You do not need to work through the book in the order set out; the sections of work can be done in the order that you wish.
- 5 There is no need to complete all of one section. If the work becomes harder as you progress through a section, see how far you can go.

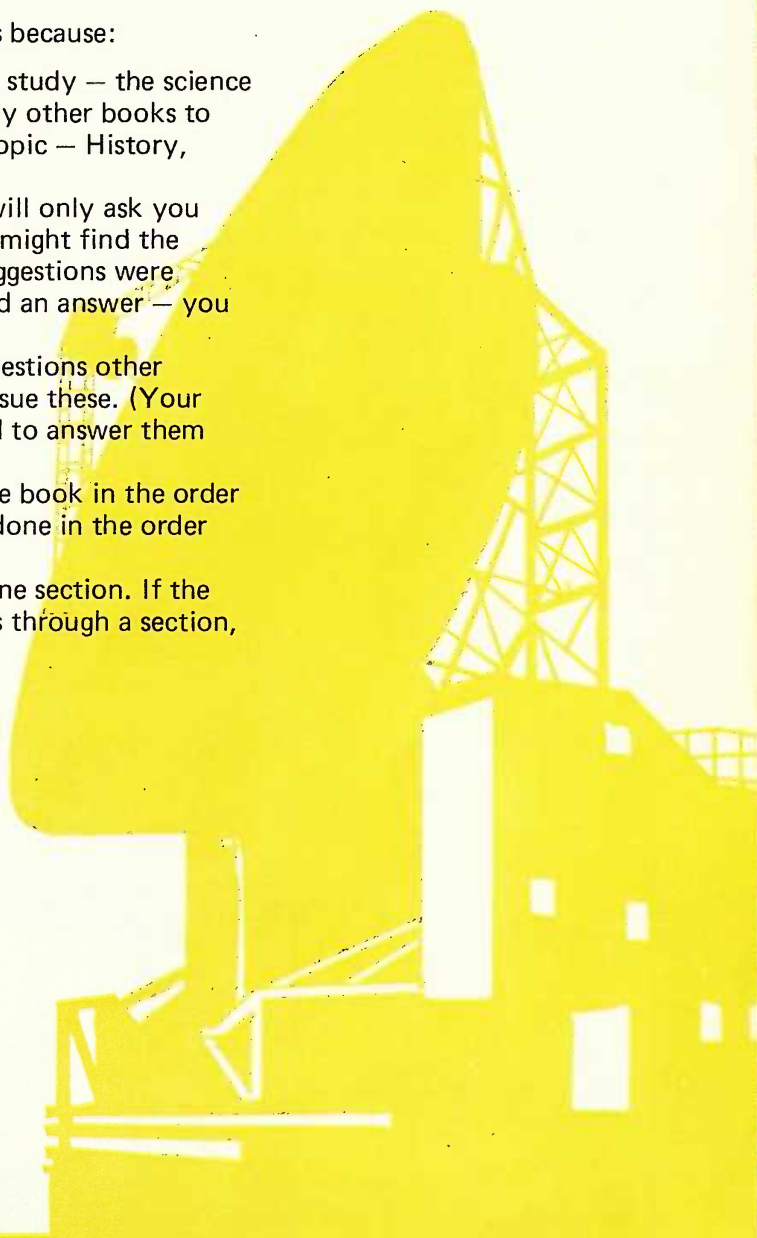

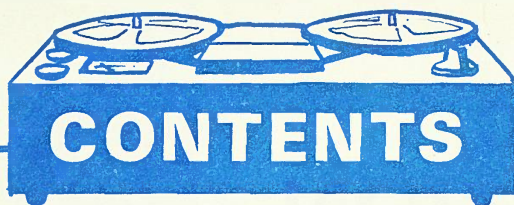

1	SENDING MESSAGES	5	7	PRINTING AND NEWSPAPERS	35
	How Far — How Fast?	6, 7		Printing	36
	Semaphore and Flags	6, 7		Mirrors	37
	Secret Messages	8		Newspapers	38
2	WORDS — AND NO WORDS	9	8	FLASHING LIGHTS AND MIRRORS	39
	Language and Science	10		Flashing On and Off	40
	Sign Language	11		Flashes and Mirrors	41
	Colour 'Speaks'	12		Signalling Ideas	42
3	SOUND	13	9	TELEGRAPH AND TELEPHONE	43
	Vibrations	14		Magnets	44
	How does Sound Travel?	15		Magnetic Attraction	45
	The String Telephone	16		Electromagnets	46
	Different Sounds	17		Using Electromagnets	47
	Music	18		The Telephone	48
4	PICTURES AND ART	19		The Telephone Exchange	49
	Paints and Painting	20		The Linking Wires	50
	Colour	21	10	PHOTOGRAPHY	51
	Colour and Light	22		Light Sensitive	52
	More about Colour and Light	23		The Pinhole Camera	53
	Signs and Symbols	24		The Camera	54
5	TOUCH	25	11	RADIO AND TELEVISION	55
	Feeling Experiments	26		Radio — How it Works	56
	More Touch Experiments	27		Building a Radio	57
	Touch and Go	28		Television — How it Works	58
6	THE WRITTEN WORD	29	12	ANIMAL COMMUNICATION	59
	The Pen	30		Pets Communicating	60
	Ink	31		Birds Communicating	61
	Chromatography	32		Bees Communicating	62
	The Pencil	33		Colour and Communication	63
	Paper	34		FLOW DIAGRAM	64
				MODEL PLANS	End papers

## Science in a Topic Series

by Doug Kincaid, County Staff Advisory Teacher, Science, Buckinghamshire.

Peter S. Coles, B.Sc., Chief Adviser, Berkshire.

Other titles:

Ships  
Houses & Homes  
Clothes and Costume  
Food  
Land Transport  
Bridges

Published by Hulton Educational Publications Ltd., Raans Rd., Amersham, Bucks.

Photolitho and printed by Cox & Wyman London, Fakenham and Reading

**NOTE:** Panels of this colour and with rounded corners represent rather more advanced work.

# Sending Messages

Who sent or sends messages by these means?  
Can you invent a message that would be sent in each of these ways?  
What other ways of sending messages can you think of?



## Section One

# HOW FAR- HOW FAST?

What other ways of sending messages have you been able to think of?

Here are some clues. Did you have these on your list?

Where are they used? Who uses them?



## SEMAPHORE AND FLAGS

The method of signalling that uses the idea of movable arms is called semaphore. If such a way is used it is clear that the colour is important; the flags must be seen.



Scout using semaphore flags



Napoleonic soldier using a Chappe machine



Ship's flags: message reads 'I need a doctor'

Which is the best colour for signalling flags?

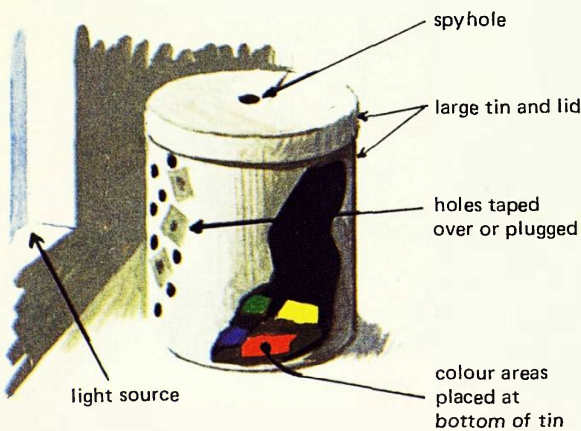

Which colour can be seen best?

All the holes are plugged. These are removed one by one until a colour can be named.

Try the colours on different backgrounds to see if this makes a difference.

Think of other places where colour is used to communicate: Rescue, Roadworkers, Airports, Motorway signs

Do your findings agree with the colours used?



Try out as many of these ways as you can and test out the accuracy of passing information by these ways.

You could paint a picture of the method that interests you most and describe:

- (a) who is sending the message
- (b) when and where the message was sent
- (c) what the message is

Take each communication method on your list and try to find out the time the message would take to travel 100 km.

Does background make a difference?

Make some charts like this:

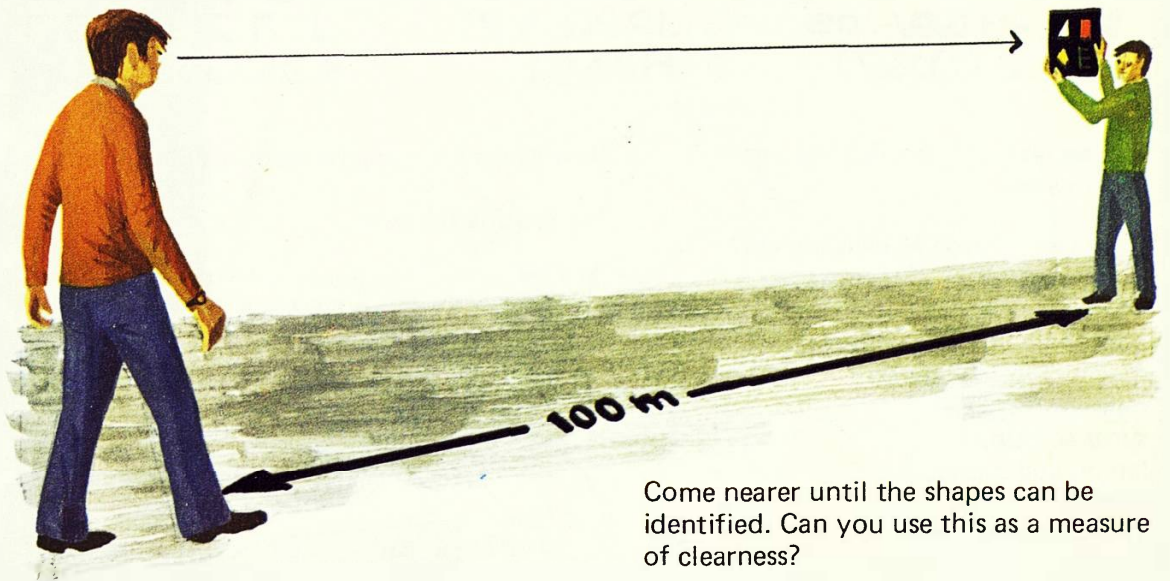
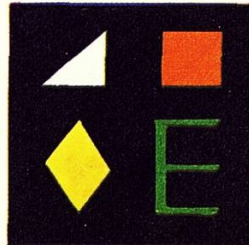
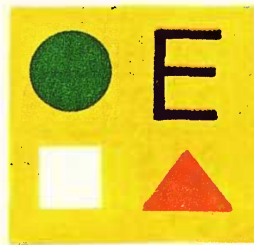
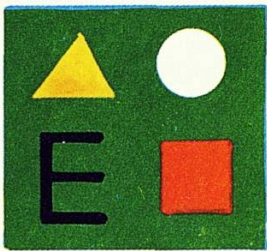

Which colour flags would you choose to signal with:

- (a) in the Arctic?
- (b) in the desert?
- (c) in the grasslands?
- (d) at sea?

# SECRET MESSAGES

Who would want to send a secret message? What kind of information would it be? The secret message might be in code.

Explore some ways of making codes (a) simple substitution

A B C D E F G H I J K L M N O P Q R S T U V W X Y Z  
 X % @ - ) ! | 0 ⊕ □ ▽ / - + // ⊕ Δ f ▽ □ £ † ∩ † × ÷ · ∞

(b) simple shift

A B C D E F G H I J K L M N O P Q R S T U V W X Y Z  
 X Y Z A B C D E F G H I J K L M N O P Q R S T U V W

(c) simple position

A	D	G
B	E	H
C	F	I

	K	
J		L
	M	

N	Q	T
O	R	U
P	S	V

	X	
W		Y
	Z	

Try breaking these codes:

(a) //)) † //) X †  
 † ⊕ @ + Δ @ / - ⊕ ⊕  
 † ⊕ £ ▽ ∩ X □

(b) P B Z O B Q P  
 J R P Q Y B  
 H B M Q

(c) Λ ∟ ∨ ∟ □ □ □ □  
 ∟ ∟ ∟ ∟ □ □ □ □  
 < □ □ □ □ □ □ □ □

The secret message might be in invisible ink.

What can be used as invisible ink?

- Try writing with:
- diluted copper sulphate solution
- cobalt chloride solution
- milk
- sugar solution
- lemon and orange juice
- vinegar
- salt solution
- washing soda solution

How can the writing be made visible and read?

Try heating the paper

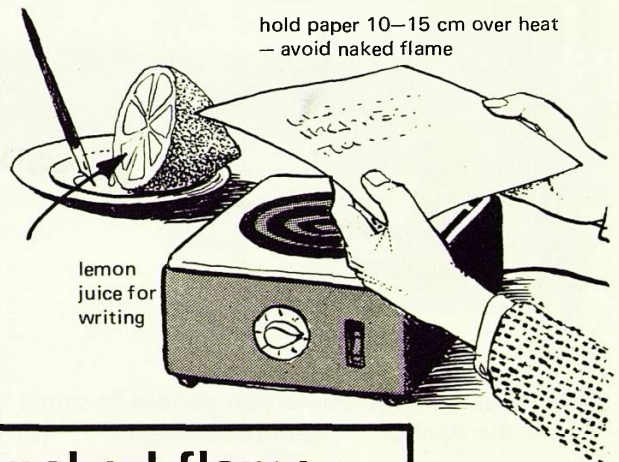

**SAFETY: Avoid a naked flame**

# Words – and no words

Speech is an important way of communication.

The fact that we speak so many different languages can be a barrier to understanding.

What is done to overcome this barrier to communication?

People who cannot hear sometimes 'lip-read' or use a hand language.



Can you think of others who 'talk' without speaking?

Find out what is meant by:

- (a) Esperanto
- (b) Interlingua
- (c) Pidgin English
- (d) Translation
- (e) Interpreting

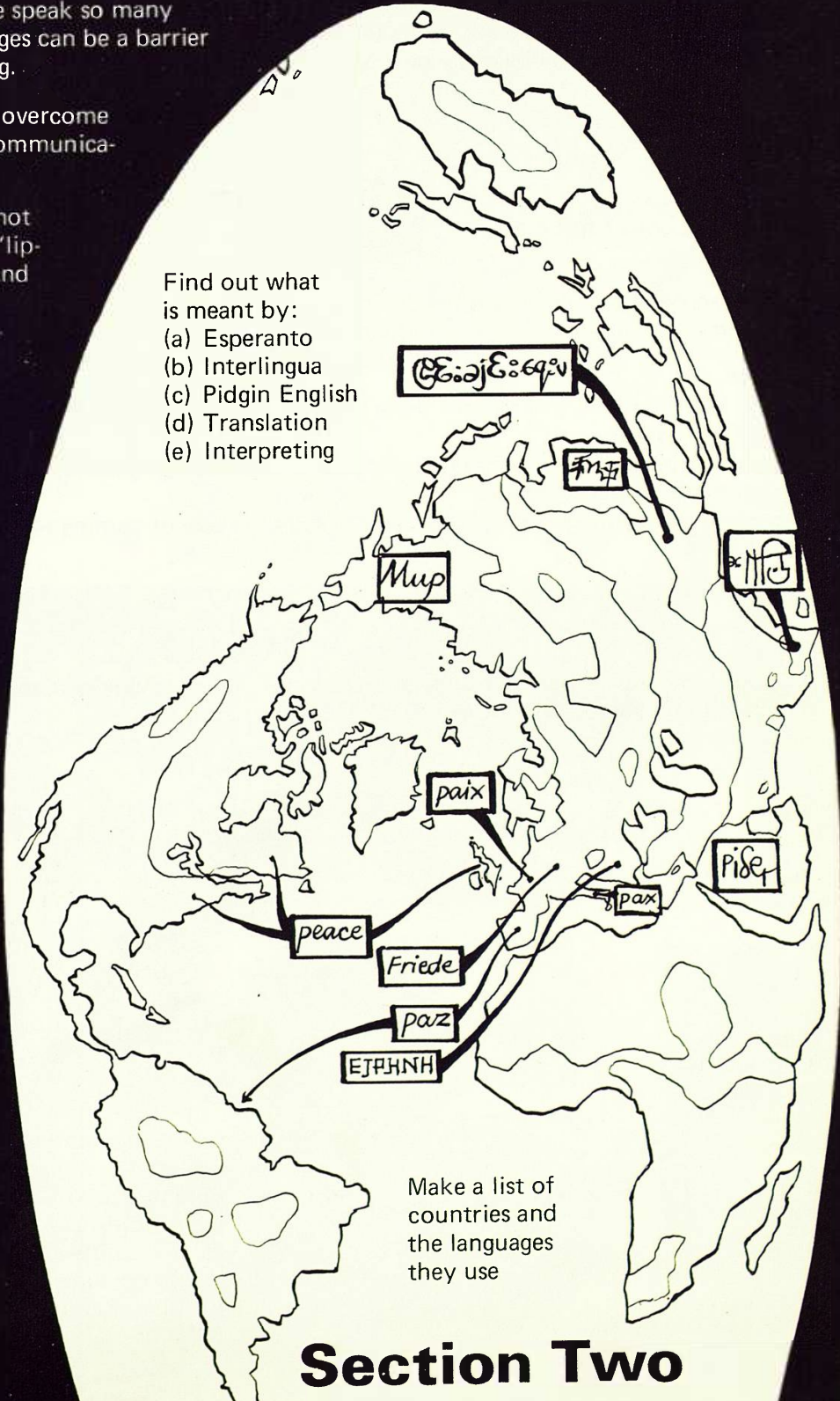

Make a list of countries and the languages they use

## Section Two

# LANGUAGE AND SCIENCE

Scientists are generally keen to work internationally. They wish to publish their research and to read about the work of scientists in other lands who are trying to solve similar problems. Language can obviously be a barrier to such free exchange of ideas.

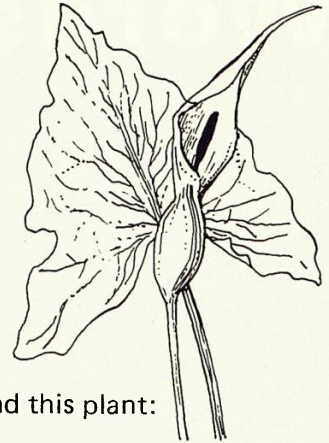

Look at this creature:

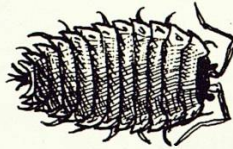

and this plant:

Here are *some* of the names used in Britain

Sowbug  
Woodlouse  
Pillbug and Slater  
*Chucky Pig*

Lords and Ladies  
Jack in the Pulpit  
Cuckoo Pint

Do you know any more names for these? Ask your grandparents and people from other parts of the country.

There could be confusion over what animal or plant was being named. It will be much more confusing internationally.

This is not good enough for Science and a systematic way of naming things has been worked out.

A Swedish naturalist, Carl von Linnæus, classified every known plant and animal and gave each two Latin names. Why do you think he chose Latin?

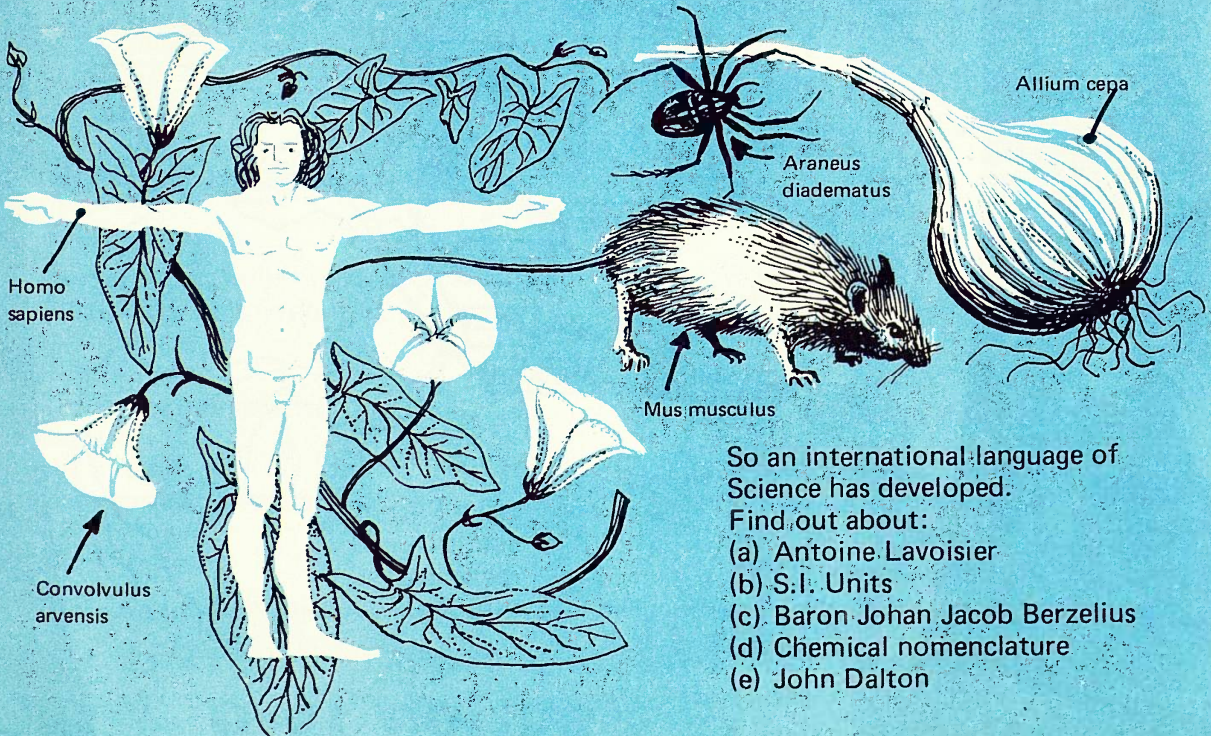

So an international language of Science has developed.

Find out about:

- Antoine Lavoisier
- S.I. Units
- Baron Johan Jacob Berzelius
- Chemical nomenclature
- John Dalton

# SIGN LANGUAGE

How well can we communicate without words?

These people are communicating by signs. Why do they use hand signals and not speech? What might they be 'saying'?

Can you use, just your hands, to 'say': Go, Come, Stop, Quiet, No . . . ? See if you can notice how people use their hands to add to the spoken word.



Sometimes special sign codes help to say things:

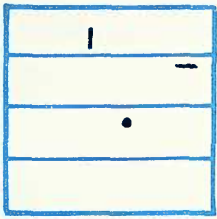

A dance 'code' — the dancer shows the step marked

NORTH CONE



A gale warning cone



The F clef

The G clef

Some signs used in music



A B C D E F G H I J K L M N O P Q R S T U V W X Y Z

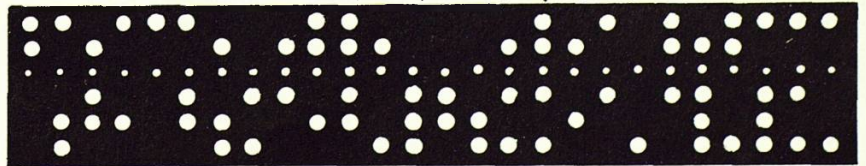

Use the code from the telex machine above and see if you can read this message. It also tells you what the two flags are 'saying'.

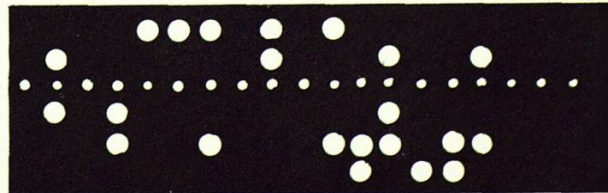

# COLOUR 'SPEAKS'

Colour is used to communicate.  
What instructions do these colours give?

## Traffic Lights

- Find in which order the lights go on and what each colour means
- Time how long each colour stays on
- Is it the same in different places?

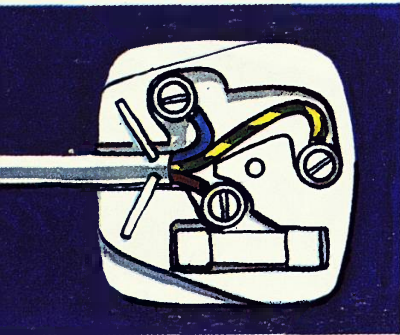

**13-amp Electric Plug**  
What name is given to each coloured wire?

Colour helps to show the value of a stamp. How many colours are used in the full set in your country?  
What colour changes have there been?  
What colour was the first stamp?

## Stamps



## Cuisenaire Rods

What is the value of each of the coloured rods? Can you find ways in which colour has helped you to learn in school?

Radio and television manufacturers use colour to see the values of some of the parts.  
Can you find the value of each of these resistors?

## Resistors

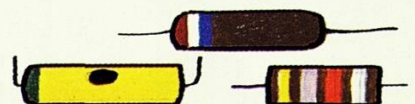

# Sound

These sound-makers are all communicating  
What other ways of communicating by sound  
can you list?  
What inventions carry sound over greater  
distances?  
What inventions record sound?

**WHAT IS SOUND?**

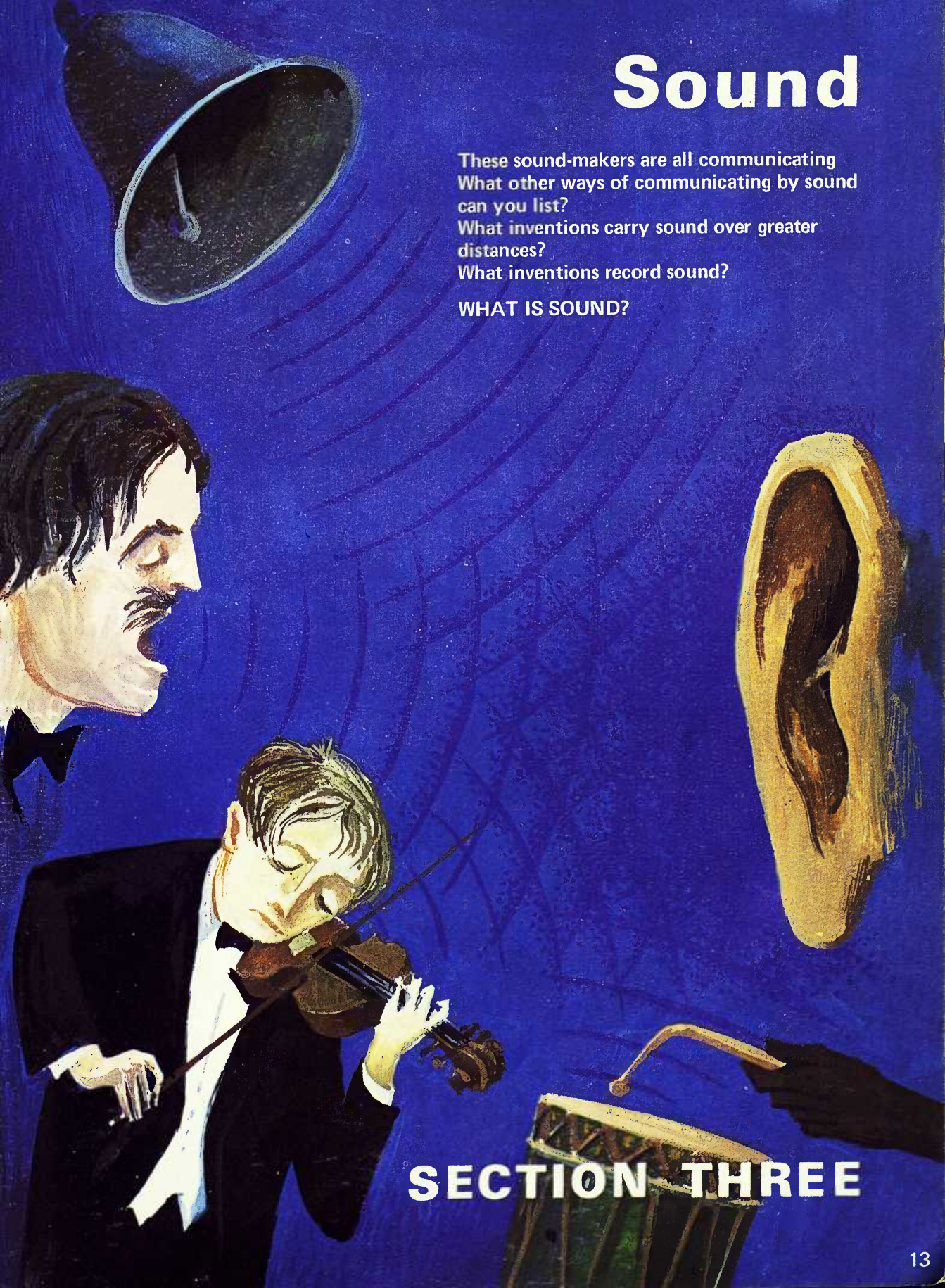

**SECTION THREE**

# VIBRATIONS

Gather an investigate various sound-makers.

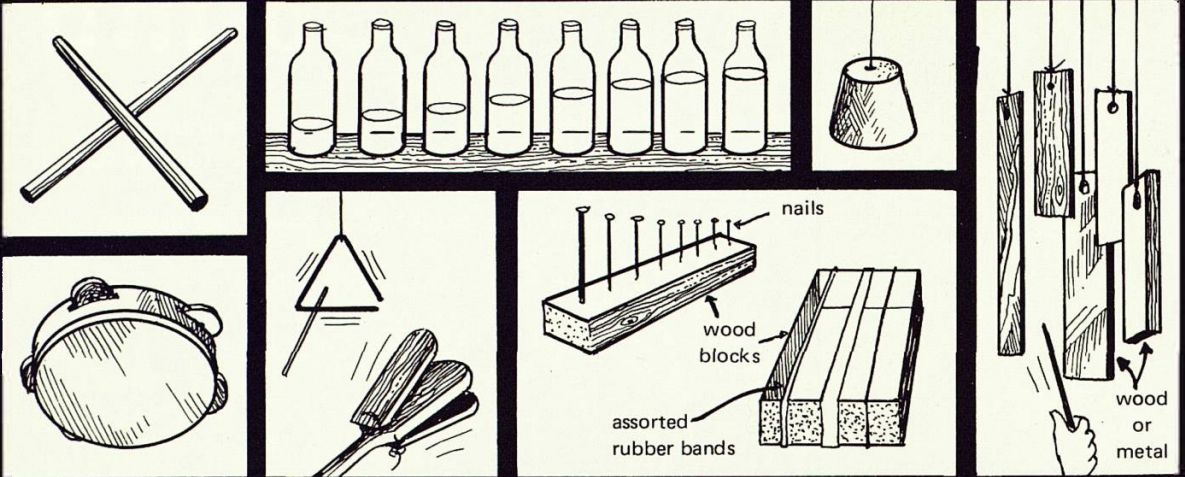

What must happen before any sound is produced?

## Sound is caused by movement

We usually hear through air. The sound-makers' vibrations cause the air to make patterns of movement. These push and pull our eardrums and so we sense sound.

Can you see or feel what is happening in the experiments below?

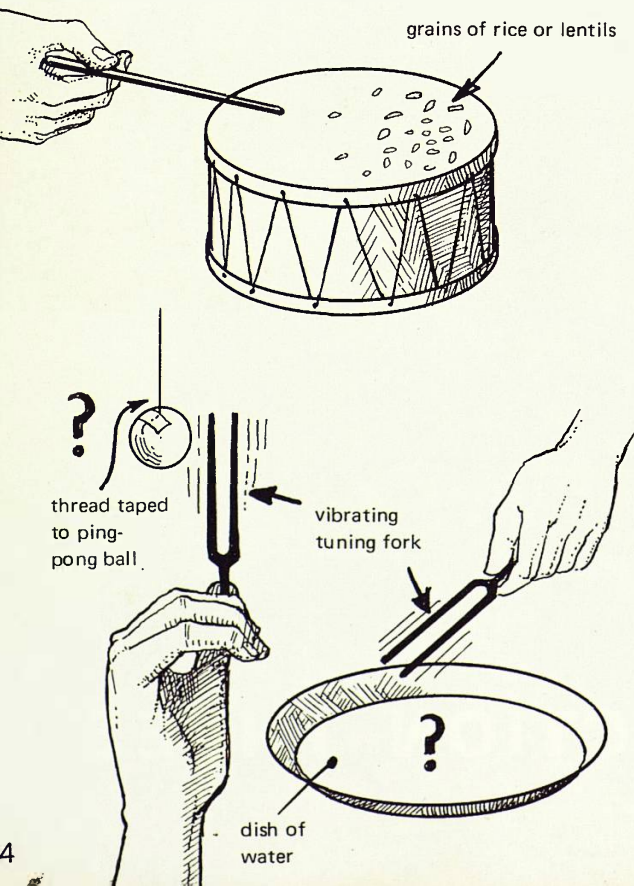

*Below:* A tin with both ends removed and a piece of balloon stretched over one end. Place your fingers lightly on the rubber. Speak — what happens?





# How does Sound Travel?



*Above:* the pin dropping experiment

*Right:* experimenting with a wooden rod and a ticking watch

## Investigate with tiny sounds:

How far away can a pin dropping be heard?

Think about controlling this experiment:

- (a) should the pin be dropped from a constant height?
- (b) should the person *see* the pin drop when hearing is being tested?

You could also experiment with a ticking watch:

- (a) How far can the sound be heard in air?
- (b) Are both ears equally sensitive?
- (c) Who has the keenest hearing?

How far can our tiny sound be heard through solids?  
Try using wood strips or dowel rod.

Investigate also with pipes, walls, railings, bench tops and floors.

How can we hear tiny sounds better?



Use a length of garden hose as a speaking tube. Perhaps a funnel each end will help. Can you think of ways to test how sound will travel through a liquid – water, for example?

# The String Telephone

An interesting way to investigate how sound travels is to make a string telephone.

You have probably tried this and found a difference depending on whether the string is slack or tight. Why is this? Carry out some investigations with the string telephone.

- (a) Which make the best earpieces: tin cans, plastic pots, card cups?
- (b) Which kind of string gives the best results: thin, thick, cord?
- (c) Can anything be done to the string to improve reception? Suppose you wet it or rub with candle wax?
- (d) Is string the best link? Perhaps thin wire would be better?
- (e) How does length affect reception? How far can you communicate in this way?
- (f) Can four-way communication be tried?



Experimenting with a two-way telephone of yoghurt pots and string

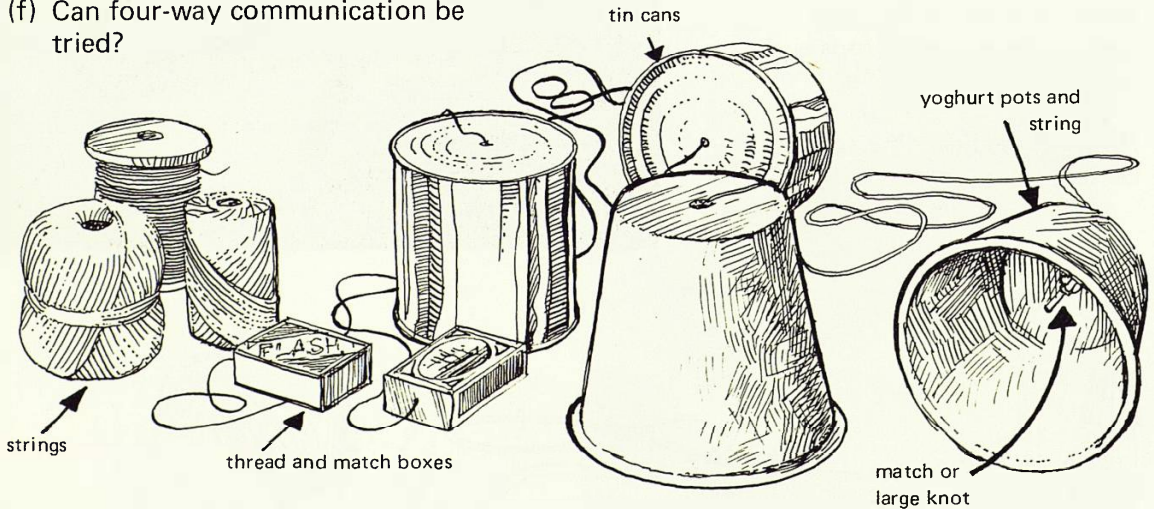

You will not need to make every one of these telephones yourself. Various pairs of friends could each be invited to make a type.

How will you measure which gives the best results?

# DIFFERENT SOUNDS

How can you make loud notes and quiet notes? How can you make high notes and low notes? What makes sounds change?

Investigate with your sound-makers.

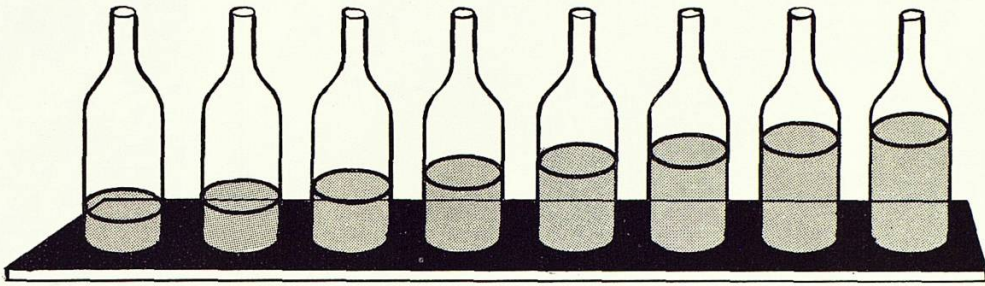

Fill eight bottles with different amounts of water. Try tapping them. Try blowing over the top. Try to make a musical scale.

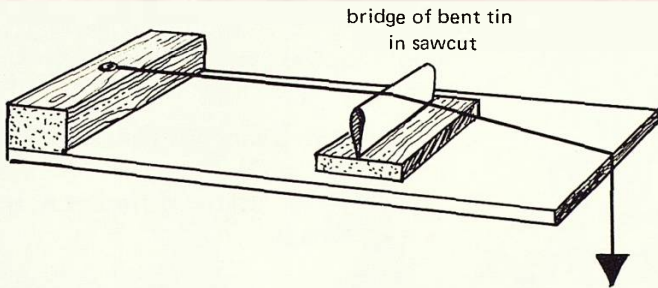

bridge of bent tin  
in sawcut

Fix a string to a board as shown; pluck. Try attaching different loads to the end of the string. Try changing the position of the 'bridge'.

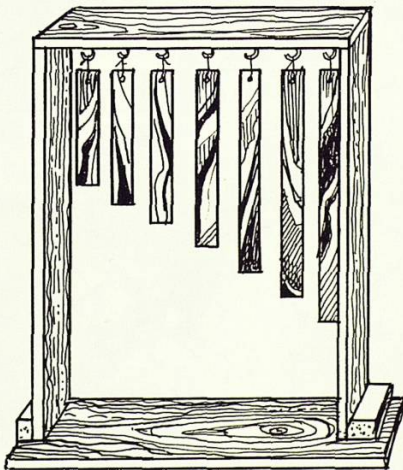

Different lengths of tubing  
or strip metal hung from  
a frame

*Below:* Strings of the same  
length but different  
thicknesses

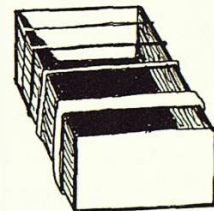
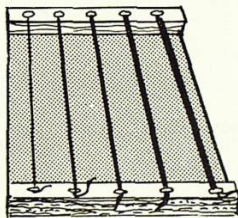

*Above:* Stretch different  
thickness rubber bands  
round a box. Pluck them.

Different lengths of metal strips and nails set  
in wood blocks

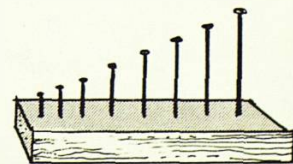
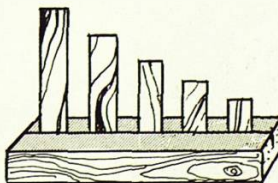

From these experiences of making sounds can you list the causes that make sounds vary?



Music can communicate mood, atmosphere and emotions.

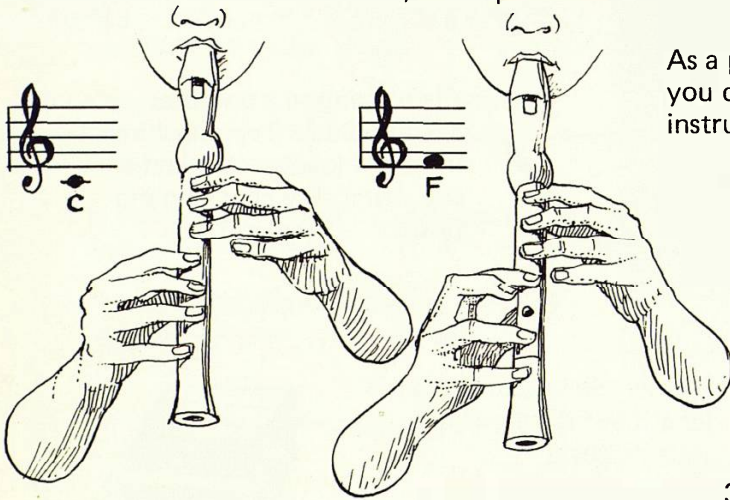

As a part of your sound investigation you could look closely at musical instruments:

- 1 What moves to cause the sound?
- 2 How are the different notes made?

Look at the recorder player

- 3 How can the sound be made loud or soft?

Look at the piano player

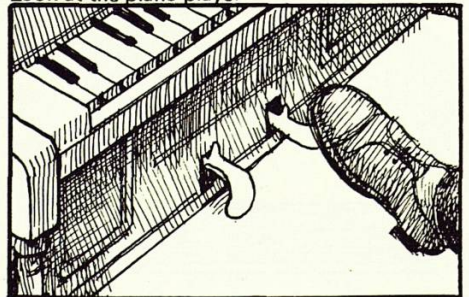

- 4 What affects the quality of the sound? Find out about Stradivarius.

Left: A collection of musical sound-makers



# Pictures and Art

## Section Four

Here is a boy communicating the excitement of a science discovery with paint and brush.



"One picture is worth a thousand words." This is an old Chinese proverb. Do you agree?

These simplified pictures are called pictograms. They are meant to communicate information in a flash. Do you know what they mean?



Try designing some pictograms for an international school.  
What symbol can you make for these?

- |                   |                          |                        |
|-------------------|--------------------------|------------------------|
| 1 The Dining Room | 3 The Headteacher's Room | 5 The Secretary's Room |
| 2 The Art Room    | 4 The Medical Room       | 6 The Kitchen          |

Answers to pictograms:

Top row: Explosives; flammable; electrical hazard; radioactive; poison risk; first-aid  
Middle row: Handle carefully; Post Office; loudspeaker; museum  
Bottom row: Children crossing; cycles prohibited; danger; no entry; roundabout

# PAINTS AND PAINTING



Here is a school using a wall and paints to record some history

Look at some of the work of the great artists communicating by paint and brush throughout the centuries

**What was used for colour?**

Until quite recent times there was no art shop at which to buy the tube of colour

**What did the cave artist use?**

**What did the Renaissance artist use?**

**What did the Dutch masters paint with?**

What was used to obtain vermilion red, umber brown, sienna brown, lamp black, Chinese white, gamboge yellow?

If you have some ideas it would be fun to try a painting using a few basic materials. You could try soot, earth, colours from plants, chalk.

## Experiment with shades, hues and tints

Cut a set of twenty thin pieces of white card (about 7 x 3 cm) Number on the back 1 to 20 for future reference. Paint these as a controlled series of shades.

That is, paint No. 1 pink (or whatever light colour you wish) add one drop of black and mix, then paint card No. 2. Repeat this for the twenty cards each time adding an extra drop of black.

When dry shuffle the cards.

Test various people to see how well they can notice slight changes. Can they place the cards in the correct order? (The numbers on the back are for checking)

You can of course do a similar test, adding a bright colour to white.

Collect some paint manufacturers' shade cards and discuss the names that have been given to the various hues and tints.

*Below:* Trying to arrange the shades in order

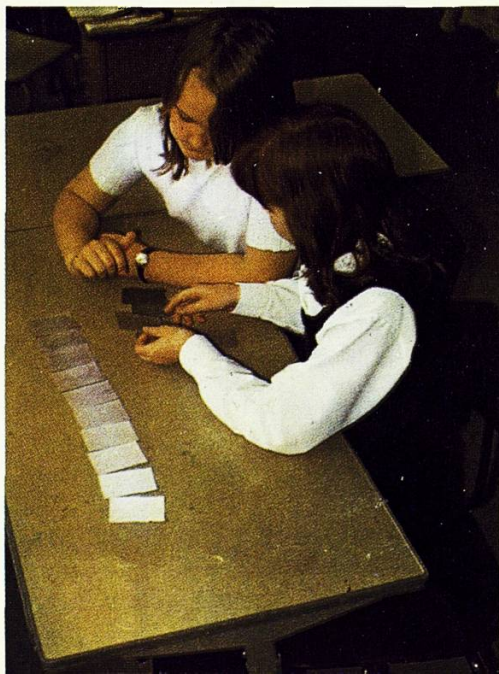

# COLOUR

You have been looking at and experimenting with colour.

Have you ever wondered why **RED** looks **RED** and **BLUE** looks **BLUE**?

To find the answers to these questions we must investigate light.

**LIGHT IS COLOUR.**  
**COLOUR IS LIGHT.**

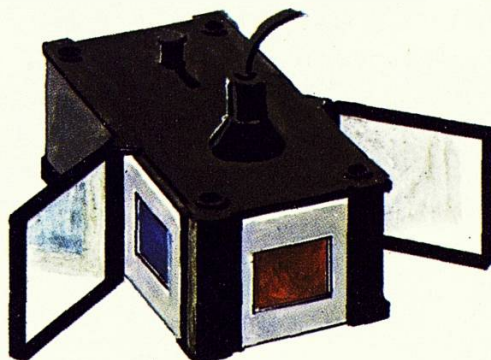

We therefore see **RED** because red light is being reflected (coming back after striking a surface) or let through, as in coloured glass.

To help you to understand this, experiment with a ray box.

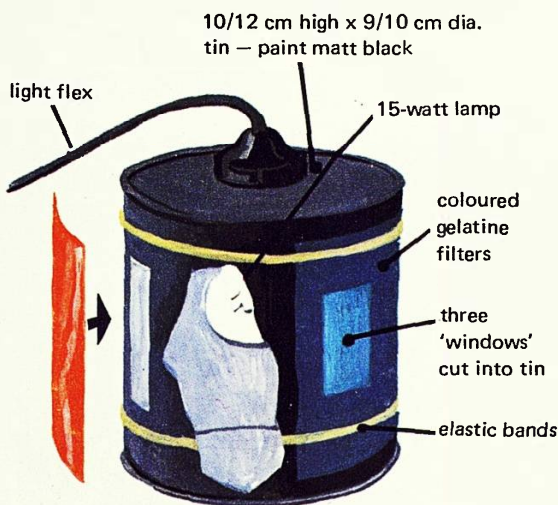

One school made their own arrangement with a tin and a sewing machine light bulb like this. You will need coloured gelatine filters to make your coloured light.

It will be best to experiment in a dull corner or a cupboard.

Make some coloured 'pictures' to put into the coloured beams of light.

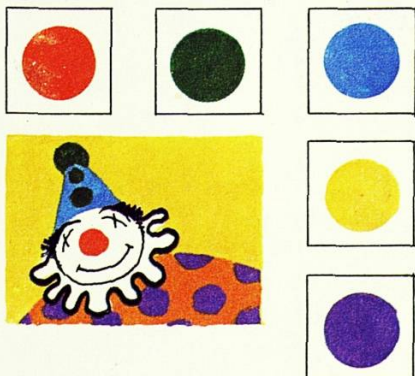

Investigate the colour pictures under red, green and blue light. Record your observations.

Coloured Light used	Coloured object as seen in coloured light			
	Red	Green	Blue	Yellow
Red				
Green				
Blue				
Yellow				
White				

Are there times when some colours look black? Why?

# COLOUR & LIGHT

Coloured lights are used to communicate.

What do these coloured lights in the photograph (left) 'say'?

You have experimented mixing paints during your Art work. Can you now tell what you will get as the pigments are mingled?

What colours will be found in the overlaps?

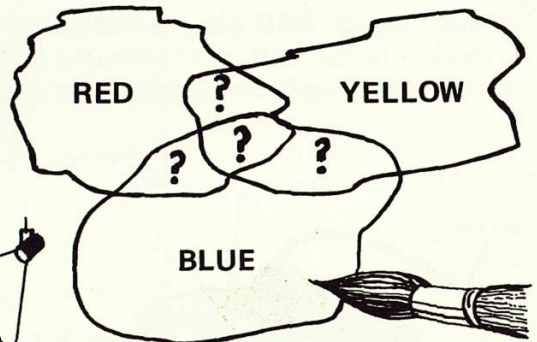

What will result if light is mixed instead of pigments?

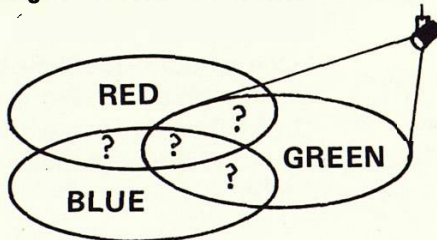

To find out, experiment with your ray box or your improvised tin like this:

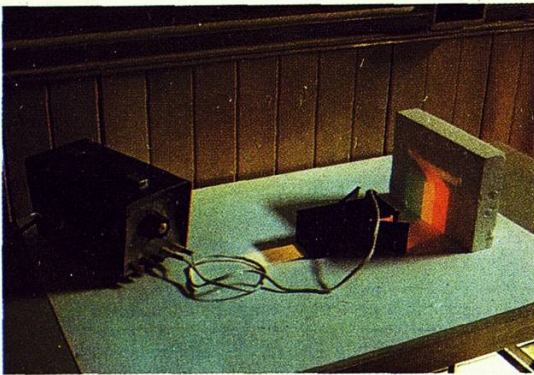

Coloured light experiments using a light box

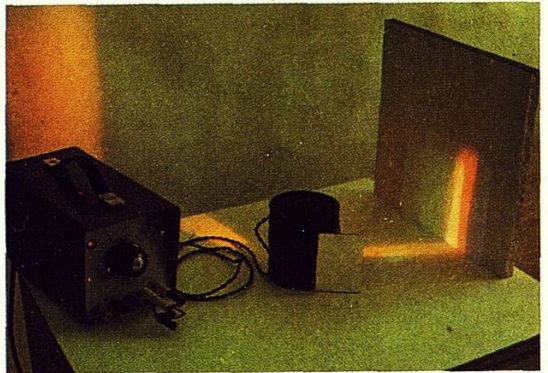

Coloured light experiments using a home-made 'colour light box'

Record your observations:

RED + GREEN =

RED + BLUE =

BLUE + GREEN =

BLUE + GREEN + RED =

Guess: Which colour mixed with Magenta will make White?  
Which colour mixed with Yellow will make White?  
Which colour mixed with Cyan will make White?  
Now check with your ray box.



# More about colour and light

You can find more about colour and light by repeating an experiment that was carried out by Sir Isaac Newton when these discoveries were first made.

Here is an illustration showing this great scientist at work in his laboratory

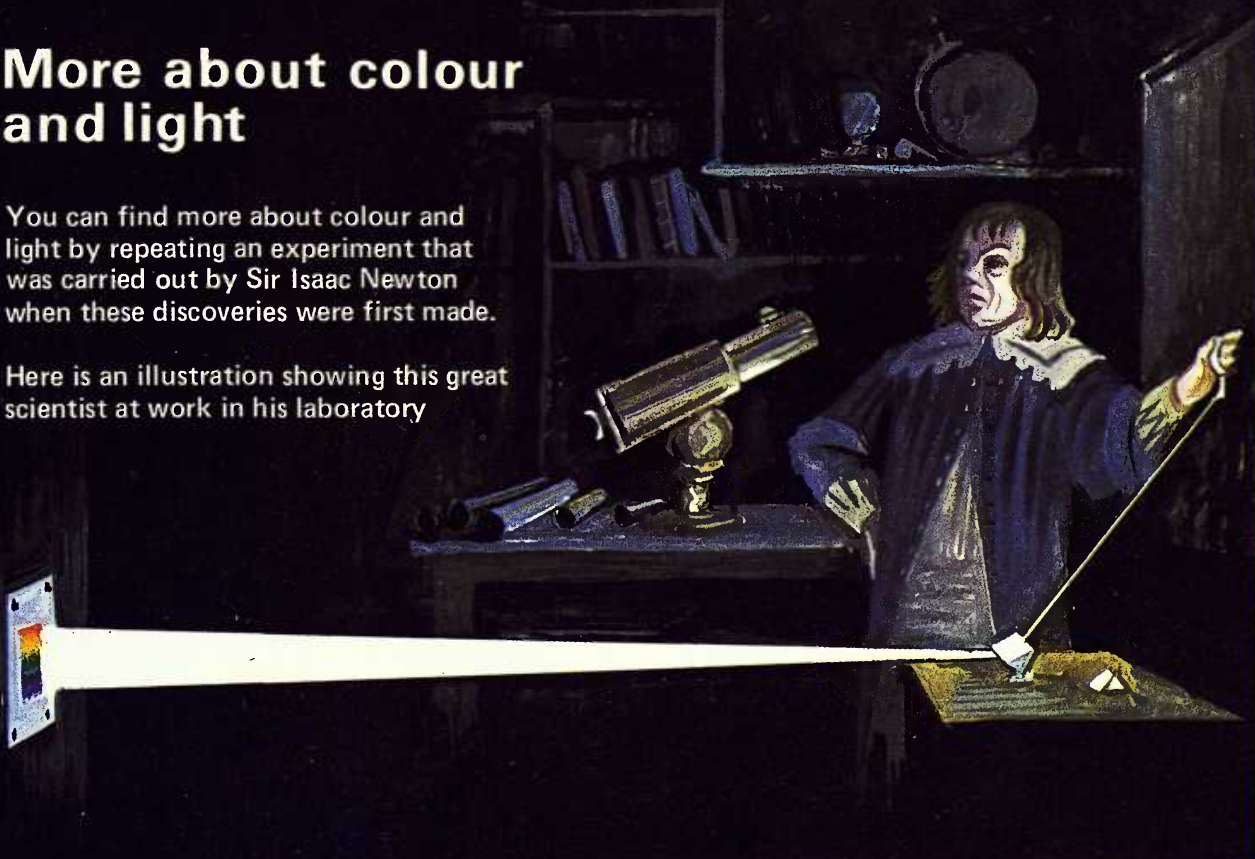

You can also try 'putting colours together' to see if you can make white. (You probably will not succeed completely because of impurities in the paints or inks you have to use.)

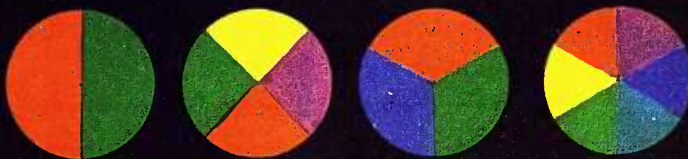

Colour some card discs and make into tops or whizzers

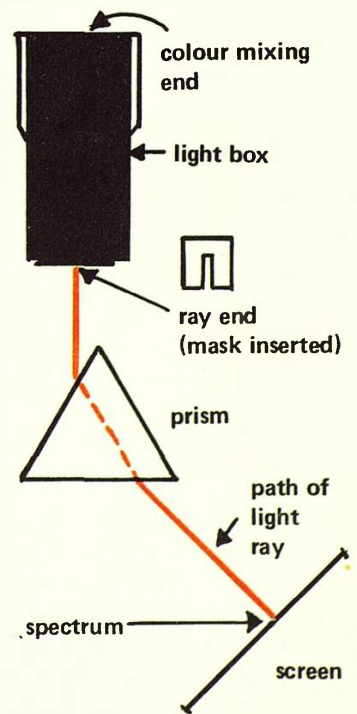
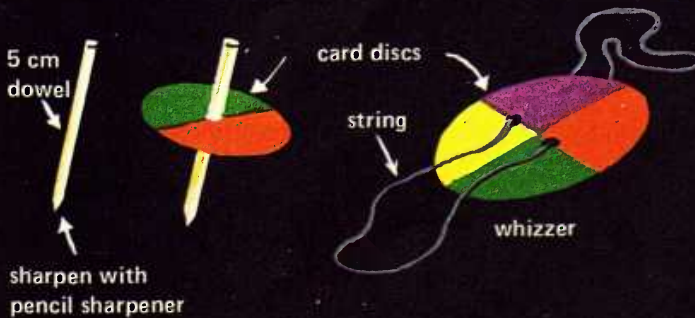

Using the light box to repeat Newton's experiment

# Signs

# and SYMBOLS

Can you find other examples of pictures being used for communicating ideas?

Trade marks and road signs use this idea.



Collect some of these symbols. What do the pictures 'say'?

Ancient civilisations used picture writing to communicate.

Who used each of these?



We use symbols to communicate in all sorts of special areas of knowledge. Do you know what these mean?

Mathematics



Music



Geography

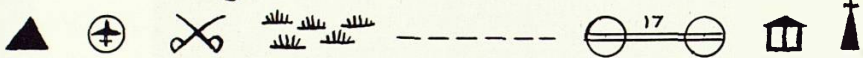

Science

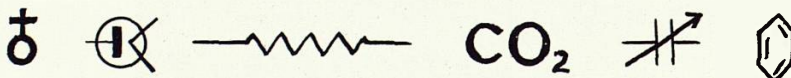

How many symbols can you collect? Try designing a symbol for yourself, for your club, for your classroom door.

If you are interested in history you will enjoy finding out how signs and symbols were used in the past.

Knights encased in armour could not be recognised, so the art of heraldry arose.

Find out about: The Divisions, The Charges, Supporters, Devices

OR = GOLD and ARGENT = SILVER (or white) in heraldry. Find out the heraldic names for RED, GREEN, BLACK, BLUE, PURPLE.

Find out also about the signs used by the craft guilds, by shopkeepers and by inns.



Per pale

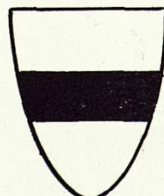

Fesse



Bend



Saltire

# TOUCH



## Section Five

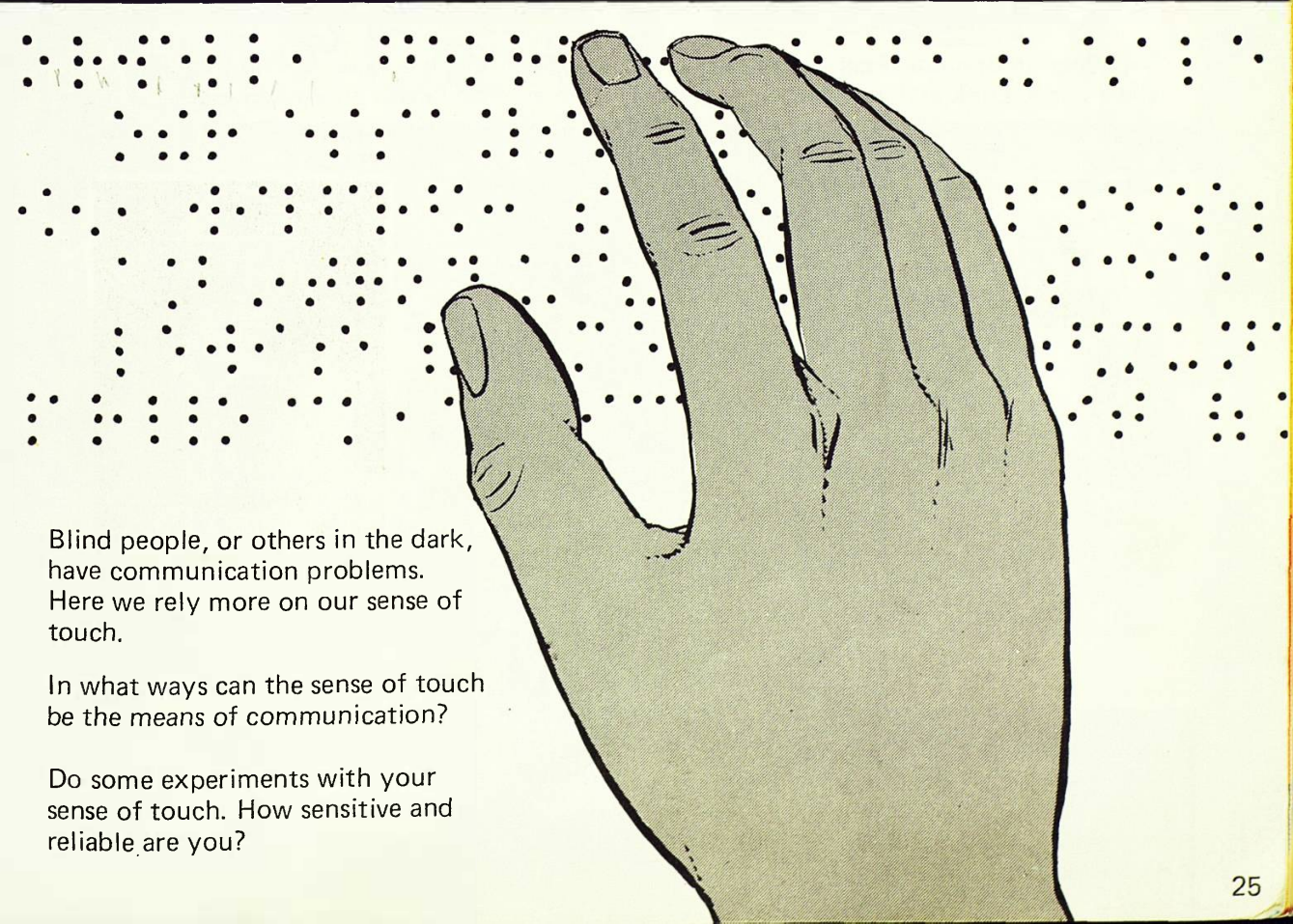

Blind people, or others in the dark, have communication problems. Here we rely more on our sense of touch.

In what ways can the sense of touch be the means of communication?

Do some experiments with your sense of touch. How sensitive and reliable are you?

# FEELING EXPERIMENTS

Communication by touch

A good way to start is to make some 'blind' bags or boxes.

These are bags or boxes to contain objects. You can put your hand into them, but you cannot see inside.

How good are you at exploring with just your sense of touch?

Some suggestions for your bags or boxes:

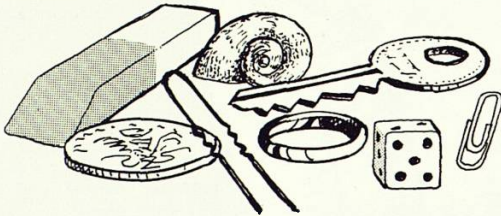
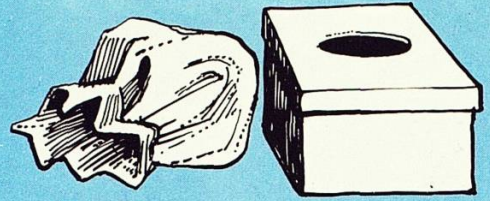

A collection of objects. Can they be identified unseen?

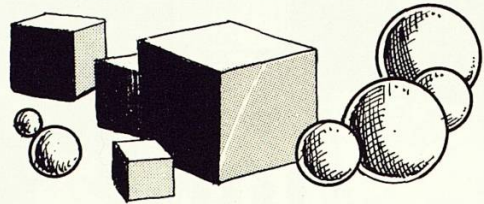

A collection of cubes and spheres. Bring out in order of size.

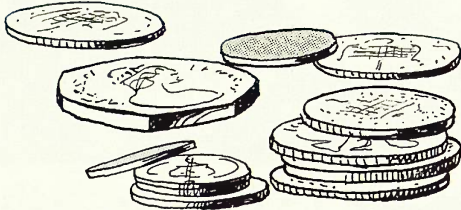

A collection of coins. Feel and record their value. Look and check.

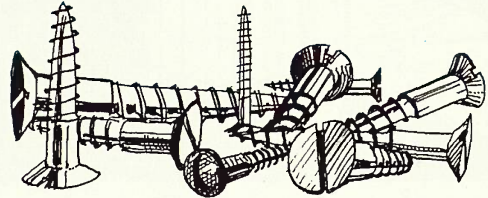

A collection of screws. Can they be sorted by length and thickness?

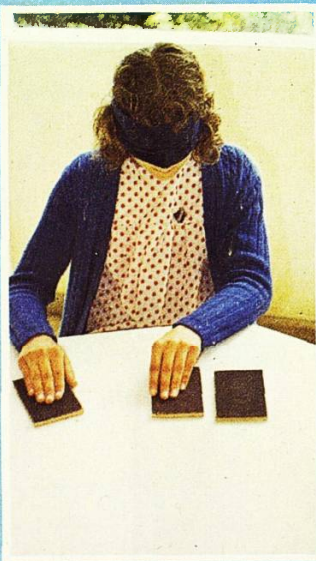

*Left:* Collect grades of glass-paper, mount them. Can they be sorted into grades by touch only?

*Right:* Make a set of papers and cards of varying thickness (tissue, copy paper, duplicating paper, cartridge paper, manilla, thin card, thicker card, strawboard). Sort these into their order of thickness just by feel.

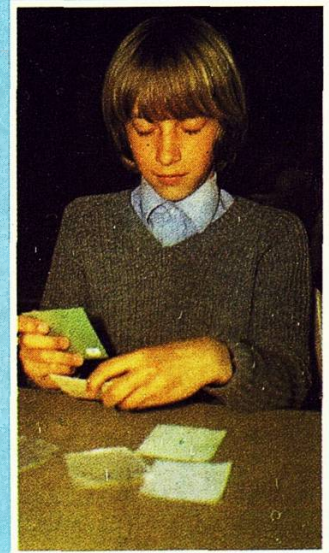

Try your experiments on as many people as possible.

Keep records.

Do these show any pattern of results?

How do nail-biters fare? Are older people better or worse than young? Do men or women have the more sensitive touch?

# More Touch Experiments

How sensitive is the sense of touch?

Cut a very small piece of paper (a square of 1 cm sides will do). Blindfold your subject.

Drop the paper from 10 cm. Do they feel it? Try 5 cm then 2.5 cm.

Try dropping it on to the palm and the back of the wrist.

(Experiment with the size of the piece.)

Are all parts equally sensitive?

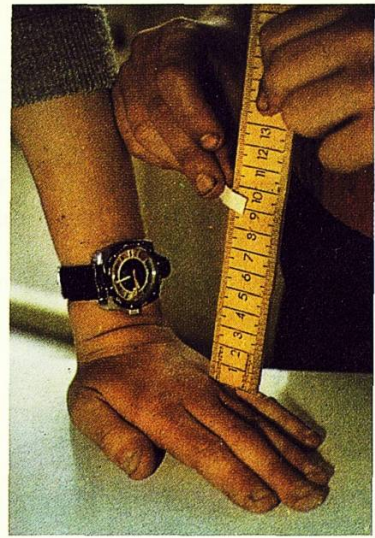

To help answer this last question, experiment with some probes made from small panel pins and corks (or *blunt* pencil points will serve).

Touch:

- (a) the back of their neck
- (b) their arm
- (c) their leg
- (d) their wrist
- (e) their palm
- (f) their finger tips

} with one, two or three points.

When can they say accurately the number of points touching them?

Try sensitivity to other things:



**Dampness test**

Use blotting paper. On equal-sized pieces drop five, ten, twenty drops of water.

Can the samples be placed in order of dampness?



**Heat test**

Arrange pots of water graded in steps of ten degrees:

Cold Tepid Warm Warmer  
Becoming Hot

Can these be placed in a correct order?

# TOUCH AND GO

A group of children working on such feeling experiments devised a 'feely' maze.

The one shown on this page gives instructions by grades of glass-paper.

Rough means *turn right*

Medium means *pass over*

Fine means *turn left*

Perhaps you can devise such a maze. But use your own ideas for giving instructions.



Fine



Medium



Rough

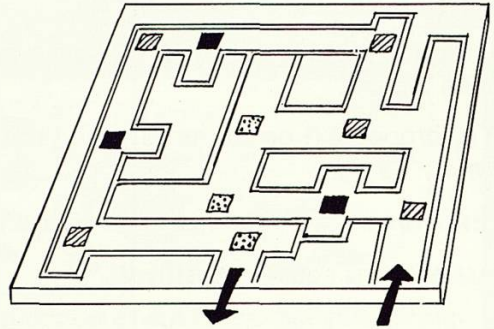

You have been involved in feeling and touching. A surgeon has to work wearing thin rubber gloves. Obtain a pair and repeat some of the early experiments, but wearing the gloves. How well do you get on now?

*Below:* Finding the way by touch

*Right:* Using rubber gloves



# The written word

## Section Six

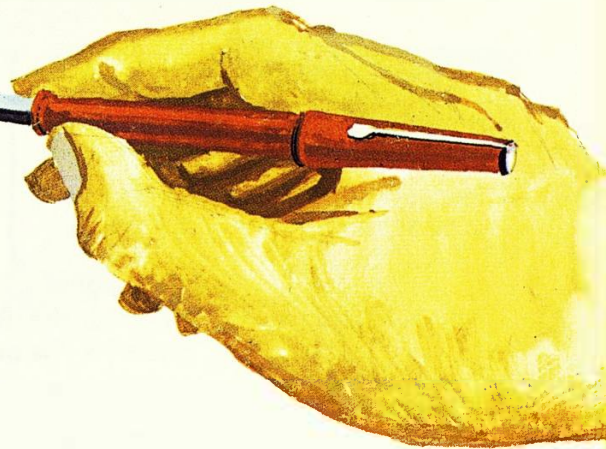

The written word is a very important form of communication.

How was writing done in the past?

How is writing done in different parts of the world?

What instruments have been and are used to do the writing?

What has been and is used to record on?



What name is given to this wedge-shaped writing of ancient Assyria?



What was this Egyptian picture-writing (hieroglyphics) written on?

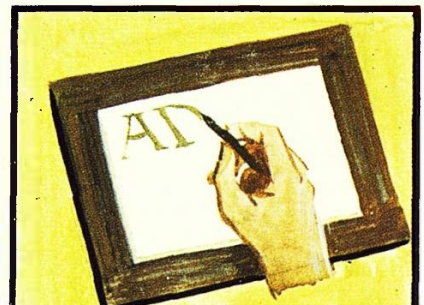

Who wrote with a sharp stylus on a wax tablet?



Which nation writes with brush and ink?

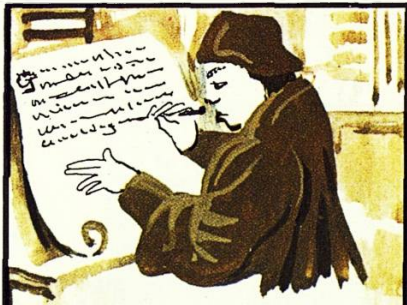

This medieval monk used a feather for writing. What is its name?



What is the name given to the craftsman who cuts letters in stone?

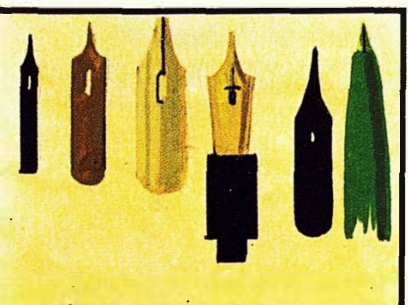

Can you name these types of nibs?

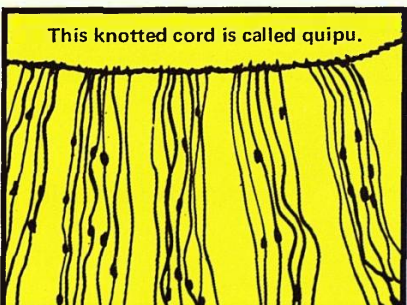

This knotted cord is called quipu.

Which people used this?

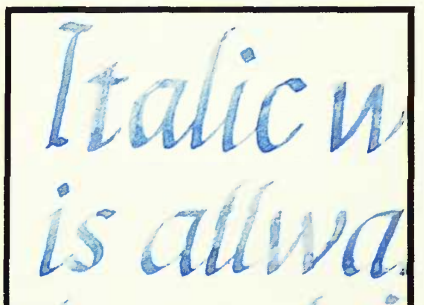

What different kinds of modern writing are used? This one is italic.

# THE PEN

Here are some things that have been used as pens in times past.

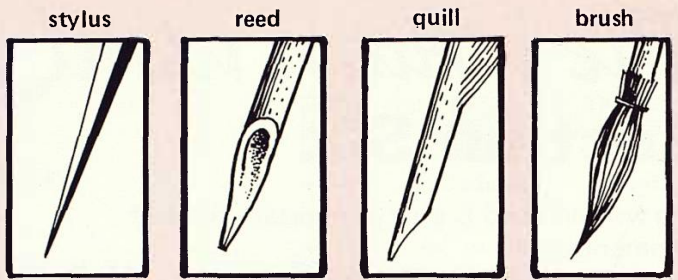

## The quill pen

How was the quill prepared? It was cut with a special little knife made for the purpose. Have you got one? It was called a penknife.

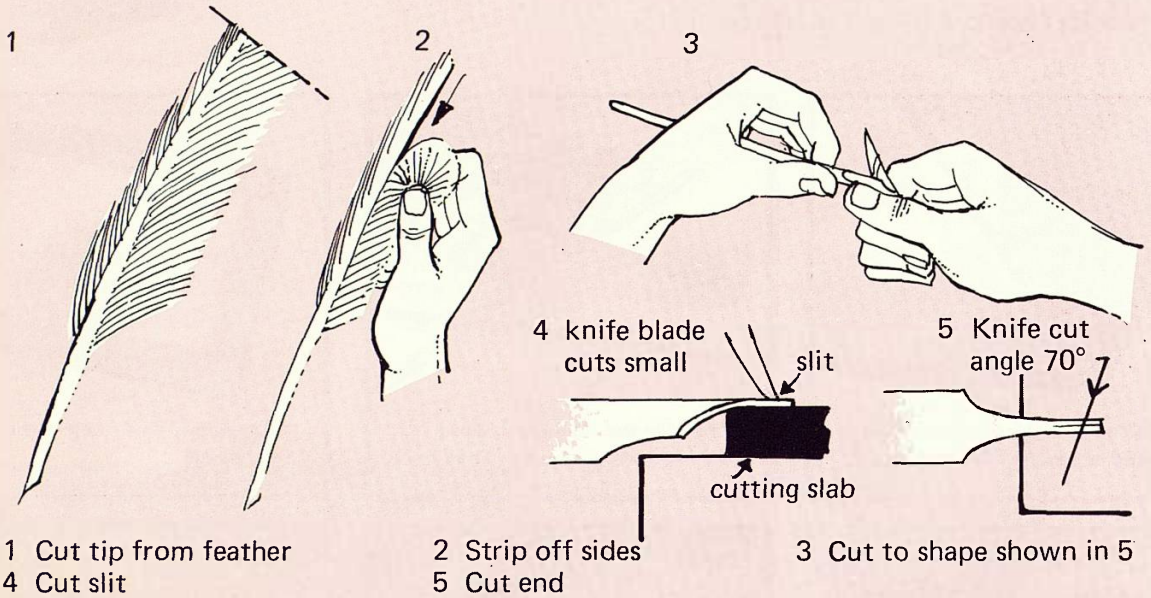

1 Cut tip from feather

2 Strip off sides

3 Cut to shape shown in 5

4 Cut slit

5 Cut end

## Metal Nibs

Metal nibs were invented in the 19th century by James Perry and William Mitchell.

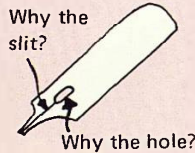

An experiment with fine bore tubes would be helpful

Examine a fountain pen. Air pressure is involved when filling one of these. What can you find out about this? Find out about L. E. Waterman and his improvement.

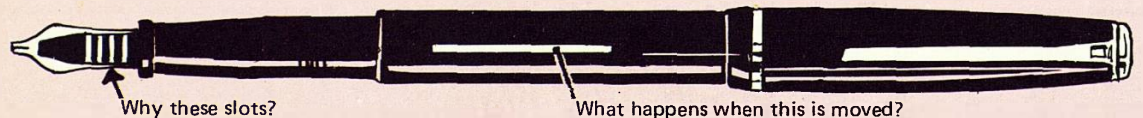

The ball point pen is a more recent invention. A particular demand by the American Air Force led to the invention of this pen.



What advantages do you think the ball point had for the men of the U.S.A.F.? Does the ball point have any disadvantages?





What different kinds of ink are there?  
What is ink?  
Is it a single substance?  
A lot can be found out about inks by doing this experiment.

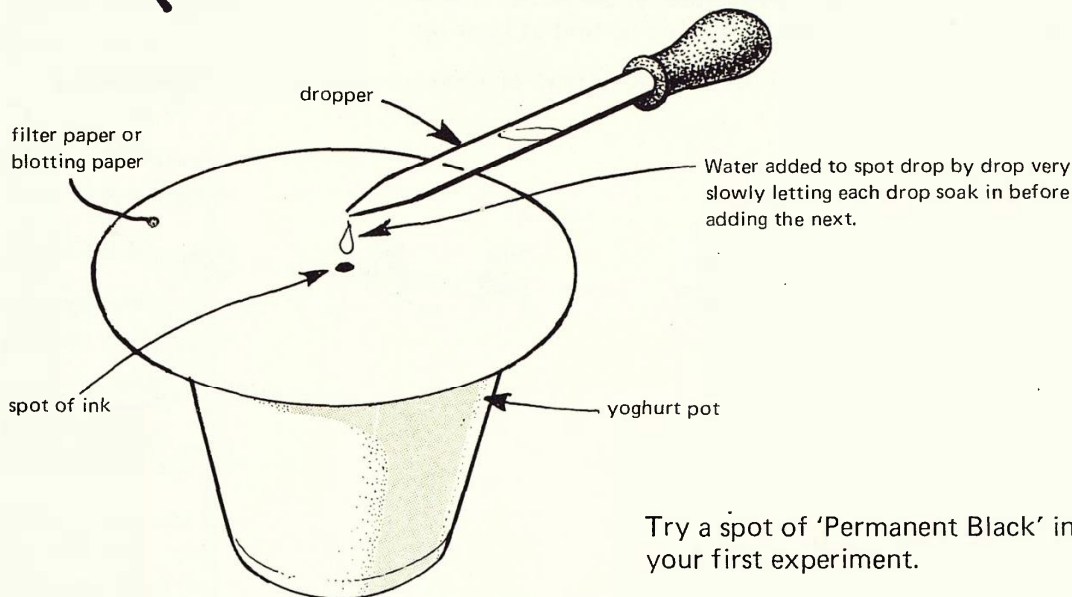

Try a spot of 'Permanent Black' ink for your first experiment.

Experiment with other black inks. Are the results the same? If not, what does this mean?  
What happens with other colours of ink?

*Ink experiment in progress*

If someone mixes two different coloured inks, can you find out what these were by this way of separating things?

Can you make your own ink?  
Some old recipes have used —  
soot and vinegar  
oak galls and green iron sulphate  
(Iron II sulphate)  
tea and green iron sulphate.

Can you invent other recipes?



# CHROMATOGRAPHY

The way shown on the last page of separating colours is called chromatography. You could use chromatography to investigate writing materials more fully.

Fibre-tip pens make a worthwhile study. Collect as many different makes of black fibre tip pen as you can. You should be able to find at least ten.

You can use the method you have already tried, or here are some other ways of doing the same thing.

The method of making a dot and letting the water soak up is better. A more constant result is obtained.

Here are ten black fibre-tip pen spots being investigated by chromatography.

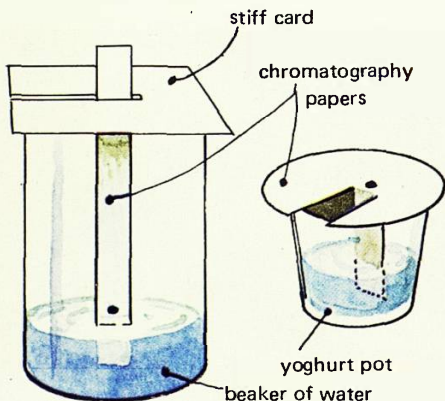
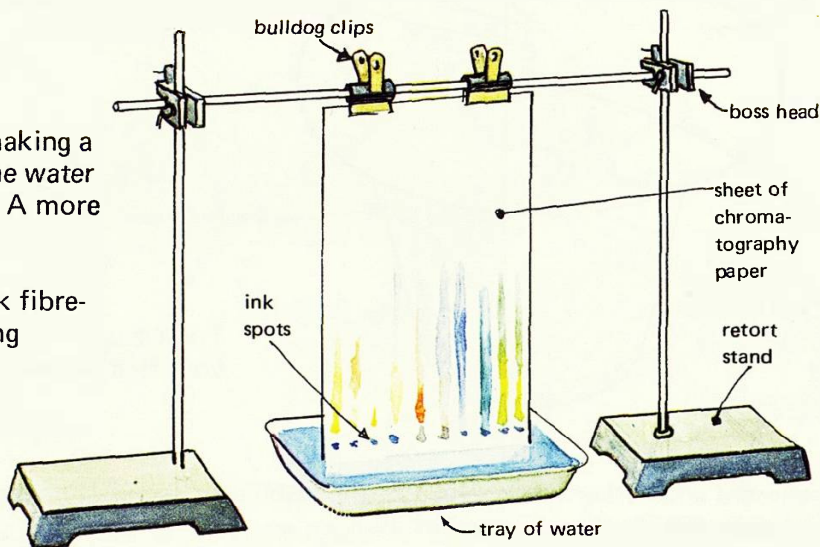

Continue your investigations with the other colours of fibre tip pens and other methods.

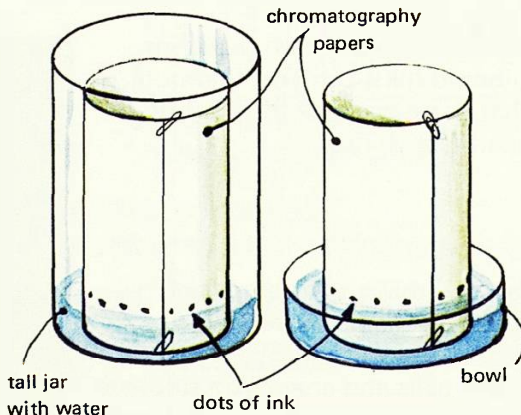

The chromatography paper can be wound into a cylinder and placed in a jar or bowl of water.

If you are interested in chromatography there are more investigations to try in *Science in a Topic – Food*

# THE PENCIL

Examine a pencil. Use it to make a mark.  
Examine the mark, using your lens or microscope.

Why does it leave a mark?  
Does it leave a mark on all materials?  
(Try: paper, glass, plastic, fabric, metal, wood, slate, china, stone, wax paper)

What other things leave a mark?  
(Try: crayon, pastel, charcoal, chalk, carbon, lead)

Try these also on the above materials.

Use your microscope. What is needed for a mark to be made? What happens to the thing you are writing with?

The pencil 'lead' is not lead.  
What is it?  
Why is it called lead?

Make a collection of pencils:  
6B 4B 2B HB H 2H 4H 6H  
What do these letters mean?

An interesting fact about a pencil lead is that it will let electricity pass through it.

Experiment with this. Sharpen both ends of the pencils.

*Centre right:* Materials you will need for the pencil experiment

*Bottom right:* The experiment in progress

Now try your range of pencils.  
What do you observe?

Can you find a pattern between the brightness of your bulb and the hardness of your pencil?

If you can find out how pencils are made you may then see a reason for this pattern.

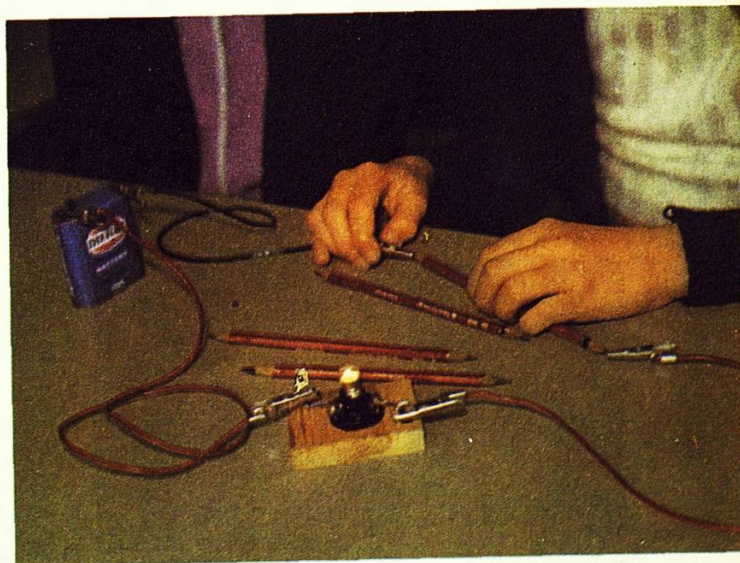
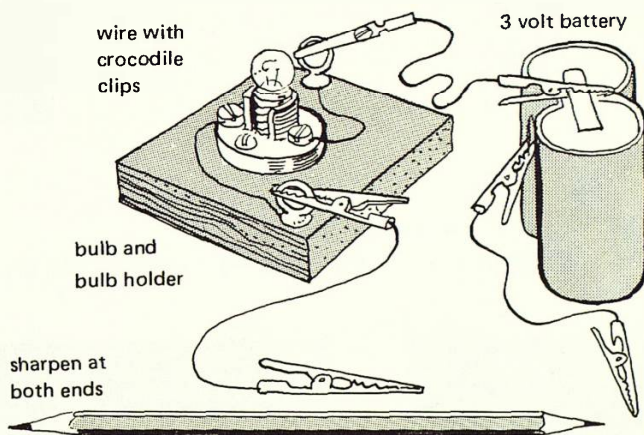
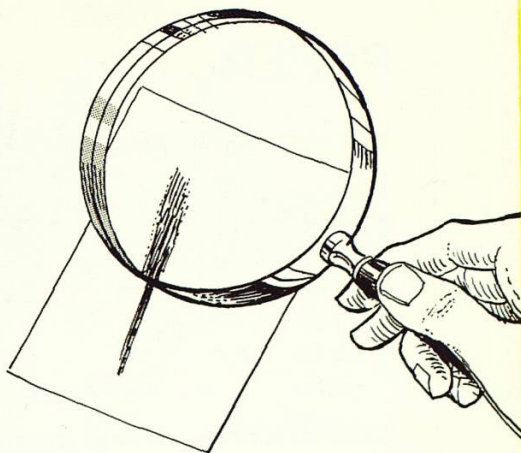

# PAPER

How many kinds of paper can you collect?

- 1 paper for art
- 2 paper for school
- 3 paper used in an office
- 4 paper used at home
- 5 paper for industry
- 6 special papers
- 7 papers that are used in science

Can you find papers that are dull, glossy, glazed, speckled, crinkly, translucent, watermarked?

What uses for paper can you find?

What is paper made from?

How is it made?



A paper collection

Can you make some paper?

Here is how some children and their teacher did this.

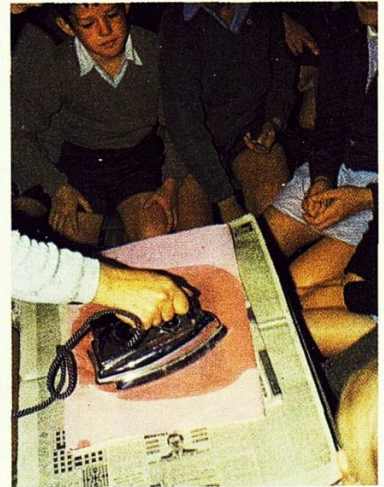

For printing a book the paper must be *opaque*.

Put some bold black print under a test piece of paper.

Can you see the print through it?

(a) on the table

(b) held up to the light

Use this as a test to grade a collection of papers for *opaqueness*.

# Printing and Newspapers

## Section Seven



editorial meetings: journalists, artists plan the newspaper



keyboard operator on linotype machine



printing plate

Which newspaper does your family have?  
How many different newspapers can you list or collect?

Why is a particular paper preferred?

Does size matter?

Is a particular feature liked — the crossword, the sports page?

How do newspapers differ?

How many differences can you list?

— size, feel, smell, type, layout?

How are newspapers printed?

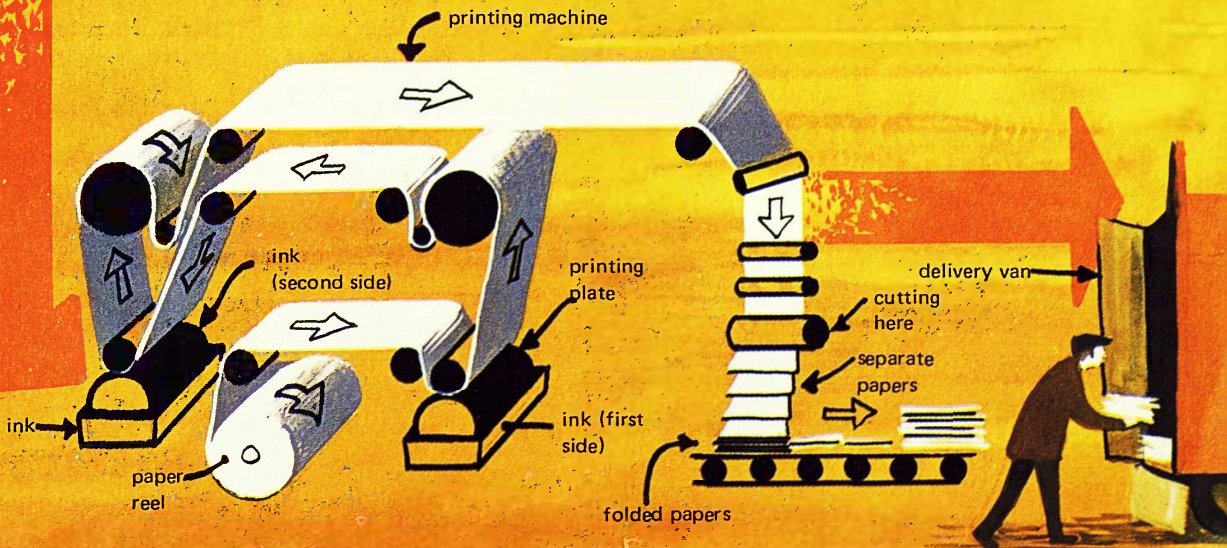

# PRINTING

“The invention of printing brought about a revolution in communication.”

This is the opinion of a famous historian.

Who invented printing?

When and where was the invention made?

Try some printing.

Try cutting a letter block – your initials for example.

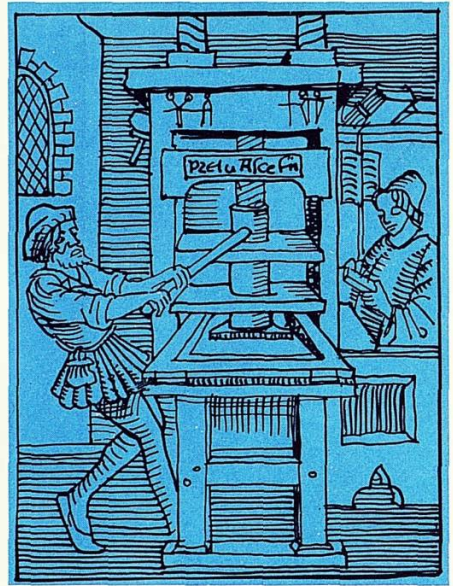
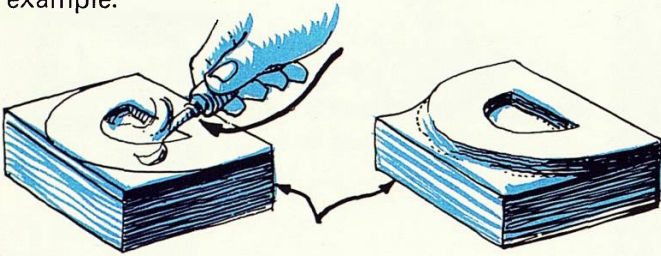

You will find that some letters need to be reversed. Which? Sort out the alphabet into two sets. Make one group of those letters that need reversing and the other of those that stay the same.



This kind of reversal can be investigated with a mirror.

Try your mirror on these words. You might think it interesting that this black word stays the same in a mirror but the blue word is reversed.

Why?



Place your mirror on this line

As part of your study of printing you might like to try making some printing ink. Here is one way:

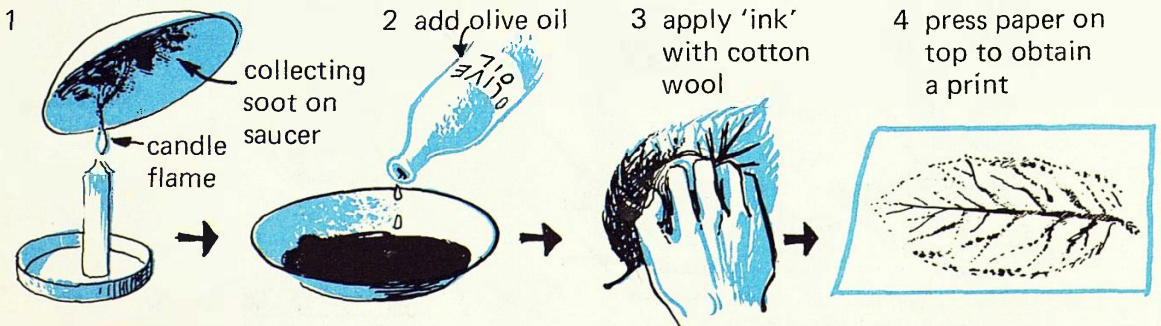

# MIRRORS



Mirrors are used to help send signals.

Here is one way.

(There is more about mirrors and signalling on page 41)

You have been looking at mirror changes in your study of printing. You might like to investigate further with mirrors and find out about the changes they make.

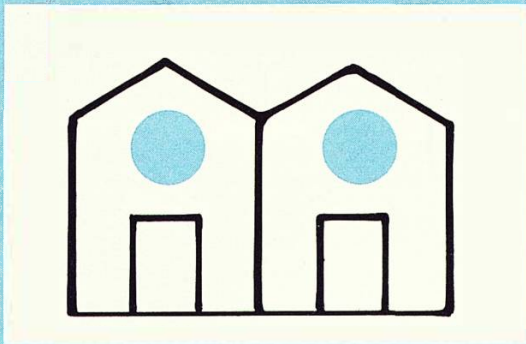

By using your mirror on this picture can you make:

- |                |                        |
|----------------|------------------------|
| 1 Four houses  | 4 Two diamonds         |
| 2 Three houses | 5 One square           |
| 3 One house    | 6 A row of six squares |

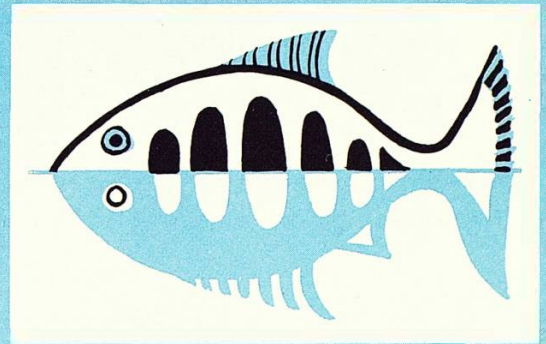

Place your mirror on the centre line of the fish

How many ways is your 'new' fish different from the original?

Repeat with your mirror facing the other way

Can you design a fish that would look exactly the same when the mirror was used? Try to design a fish that is very different when the mirror is used.

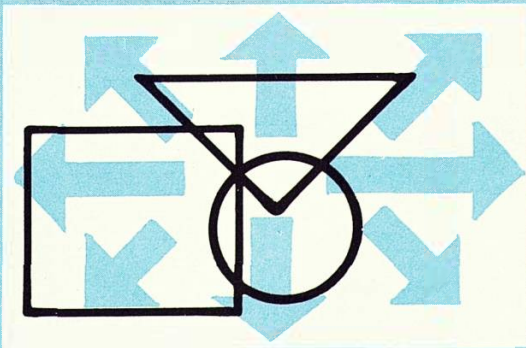

Move your mirror across the design in each of the directions shown.

What different shapes and designs have you seen?

Would any of the designs make a good pattern for Art or Needlework?

Experiment with your own shapes.

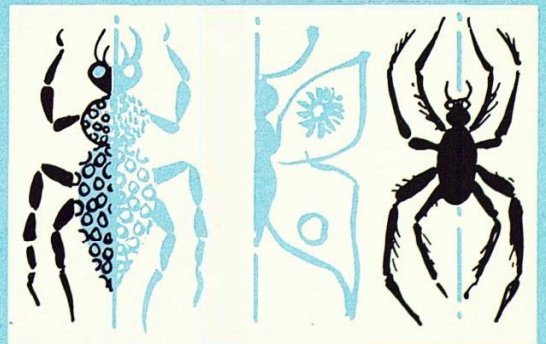

Place your mirror on the centre of each insect.

Do you make new insects?

Can you make any new fantastic creatures with your mirror?

# NEWSPAPERS

We use newspapers for all sorts of uses other than communication.

You could investigate any or all of these

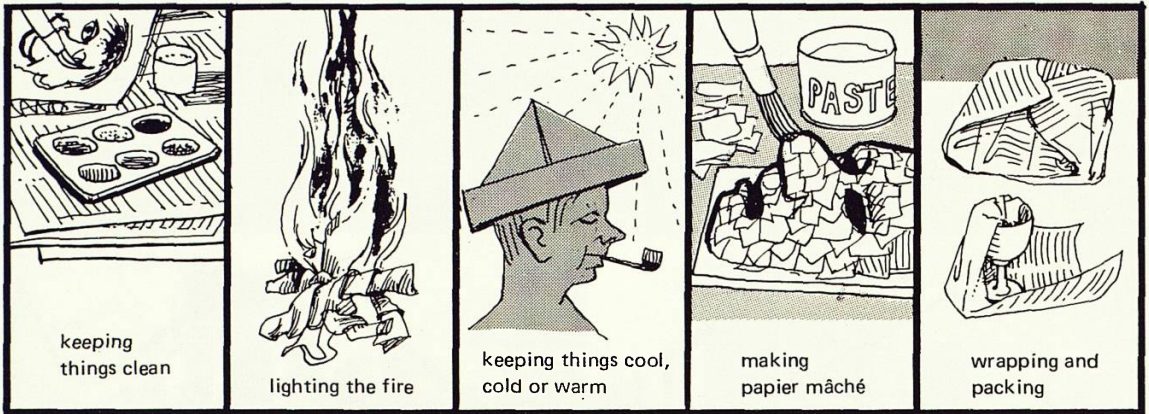

The following work continues the investigations started on page 34.

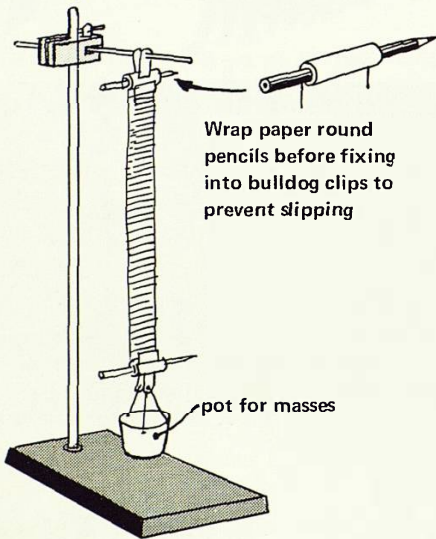

Is one paper stronger than another?  
Is paper stronger in one direction?

Here are some suggestions to try.

Think about the size of your strips each time.

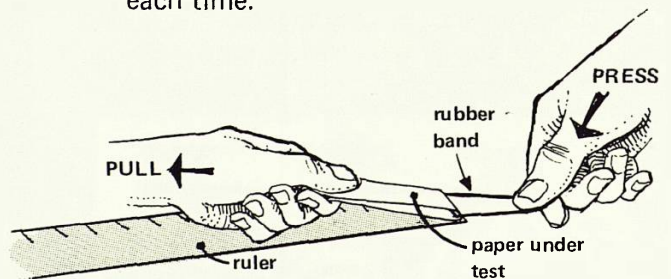

Your findings could help a project 'Building with Paper'. This is dealt with in Section Six of *Science in a Topic – Houses and Homes*.

An investigation into how water is absorbed (soaked up) by different papers, and whether more readily in one direction than another, would be a good follow-up experiment.

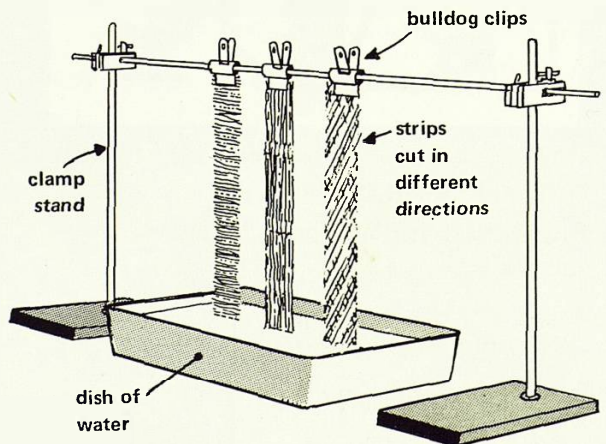



# Section Eight

# Flashing Lights & Mirrors

A flashing light can be used to attract attention or the flashes can be timed to 'spell' out a message.

Try sending such messages yourself using a torch or mirror. Here is the Morse Code which uses a pattern of long and short flashes.



The heliograph was used during the Boer War to flash signals. The reflecting mirror was used if the sun was behind the operator

A ..	M _ _	Y _ _ _
B _ _ _	N _ .	Z _ _ _
C _ _ _	O _ _ _	1 . _ _ _
D _ _	P . _ _	2 . _ _ _
E .	Q _ _ _	3 . . _ _
F . . .	R . .	4 . . . _
G _ _	S . . .	5 . . . .
H . . .	T _	6 _ . . .
I . .	U . .	7 _ . . .
J . _ _	V . . .	8 _ . . .
K _ _	W _ _	9 _ . . .
L . . .	X _ _	10 _ . . .



Police, ambulances and emergency vehicles use a flashing light

# FLASHING ON AND OFF

Here is a simple circuit with a light on. Try this for yourself.

(*Science in a Topic – Houses and Homes*, Section Eight 'Electricity' will help you with a simple study of electricity.)

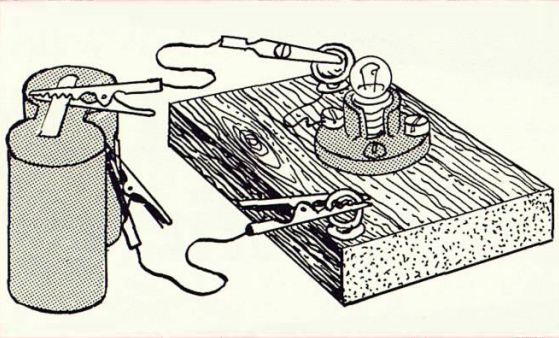

Can you put the light off and on? How many ways can you do this?

One way would be to add a switch that could be used to flash the light on and off as it makes and breaks the circuit.

Switches can be bought but here are some suggestions for making your own.

## three home-made switches

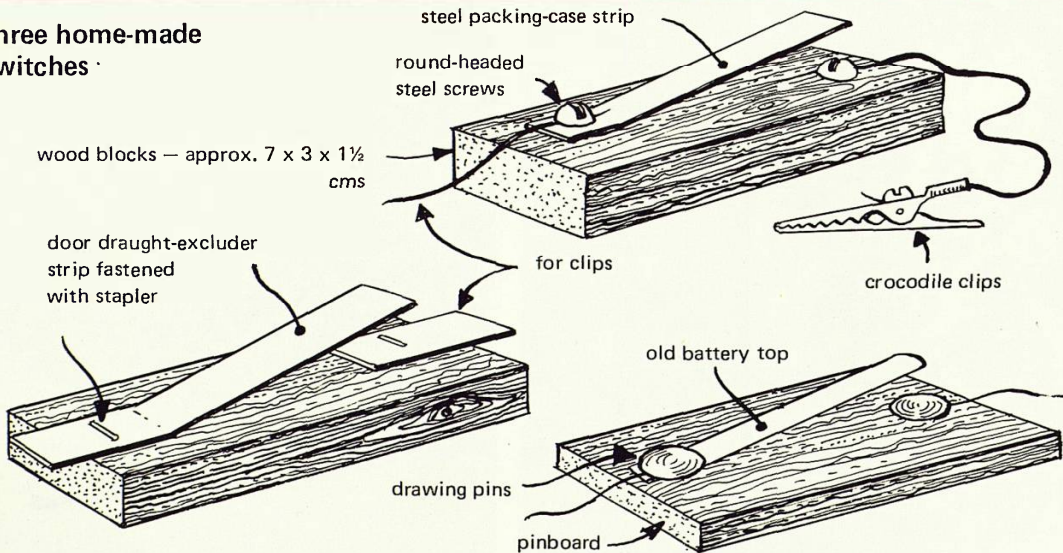

Try your switch in various places in the circuit. Does this make any difference?

Try using the Morse Code to send a message.

*Left:* A simple circuit with switch

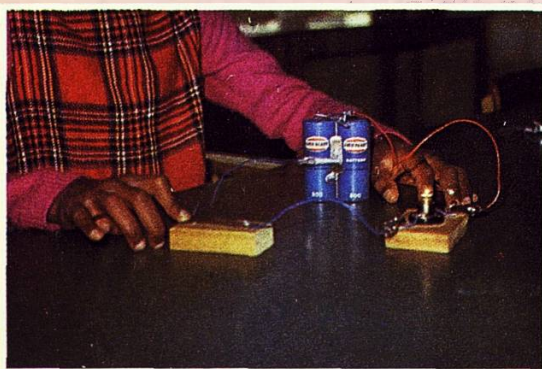

# FLASHES AND MIRRORS

Can you send your message by keeping the light on continually but flashing the message by means of a mirror?

What happens if there is a barrier to the passage of the flashes?  
Can a mirror be used to pass the flashes round a corner?

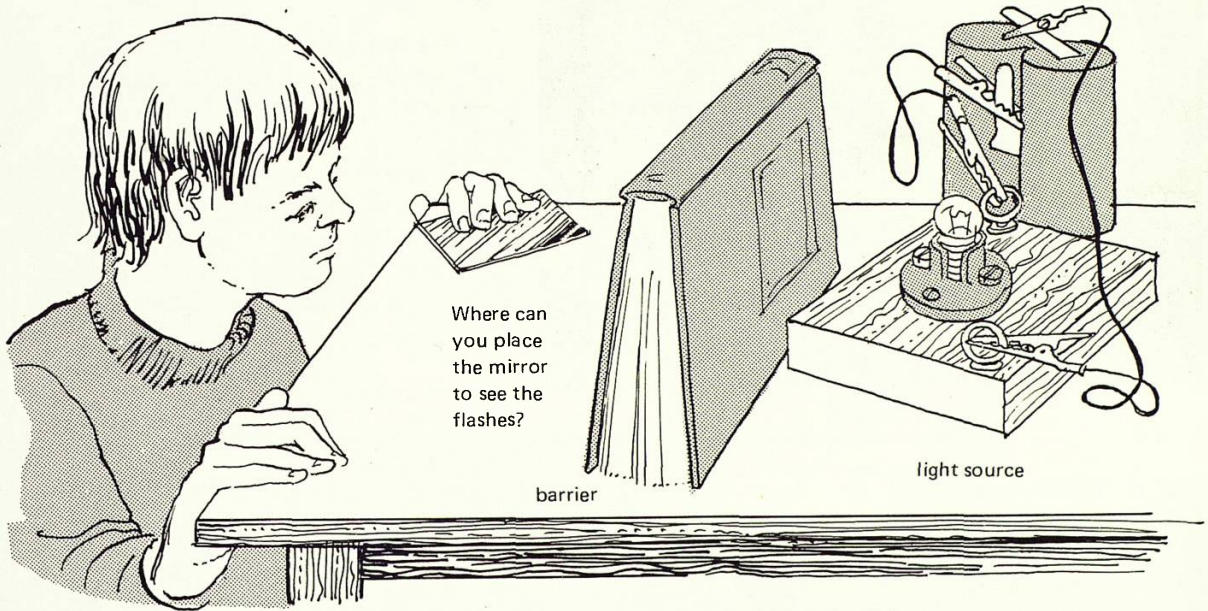

Long ago soldiers used their polished shields and the sun to flash warnings and messages. You can try this with your mirror. Do remember, on no account ever look directly at the sun or use your mirror to dazzle others. The sun is so bright it can damage eyes.

You will have noticed that the mirror can change the direction of the light. One group of children found more about this by measuring angles. Here is the arrangement they used.

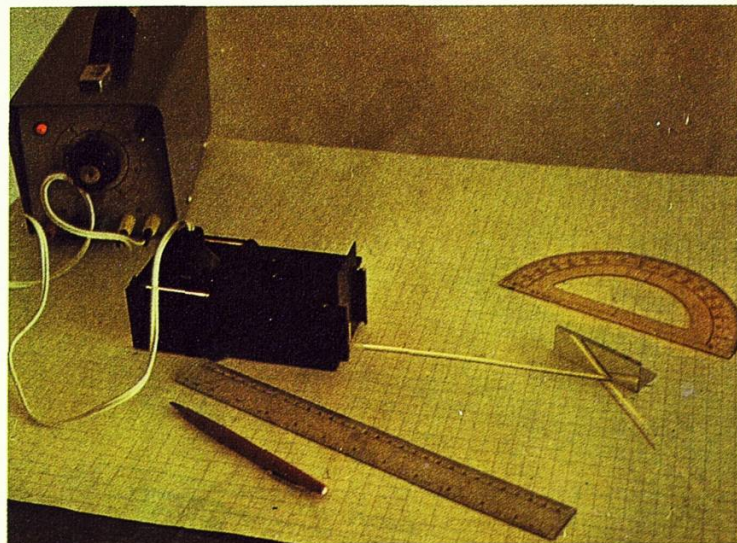

# SIGNALLING IDEAS



Here is an idea for sending signals.  
Make and try this.

A's switch is working B's light  
and B's switch is working A's  
light.

These boys are showing you  
their whole set-up. They really  
used their system to signal  
to each other when out of sight,  
i.e. in two separate rooms.

Here is how the circuits were made:

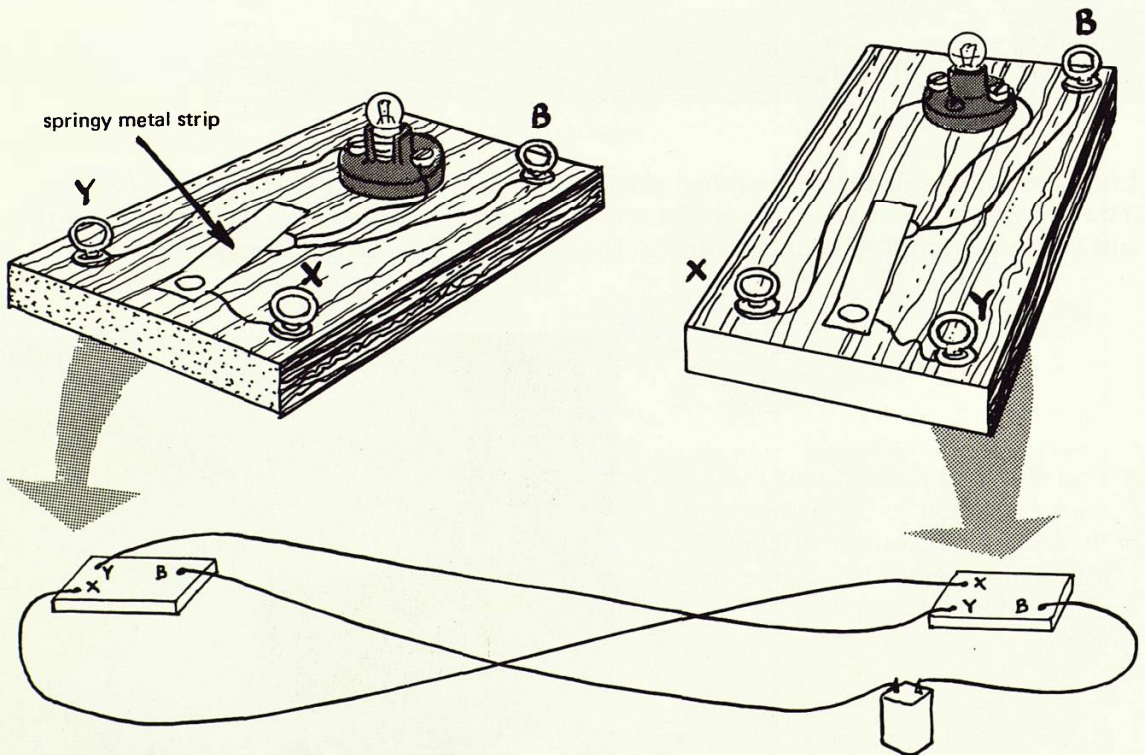

In the next section you can find out how to make buzzers, clackers and sounders. These could be used instead of lights.

# Telegraph and Telephone

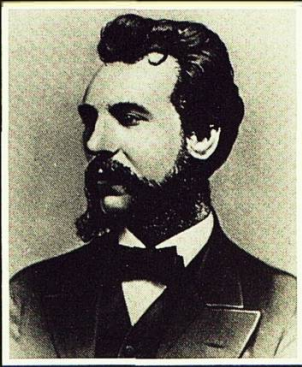

*Above:* Alexander  
Graham Bell  
1847–1922

*Right:* Lord Kelvin  
1824–1907

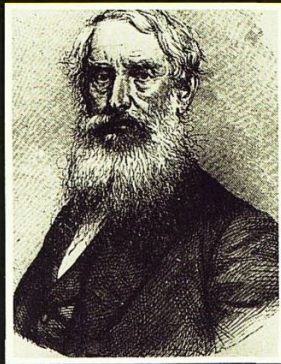

telephone  
transmitter

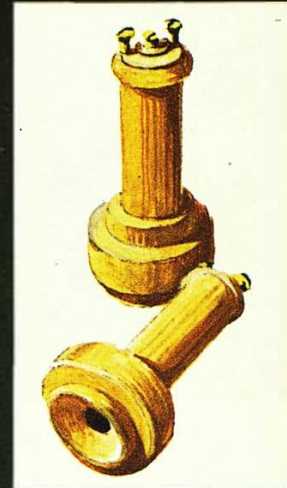
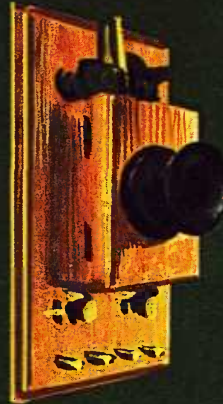

telephone  
apparatus

Here are some famous inventors and famous inventions to do with sound communication.

Can you match them?

*Right:* Thomas  
Alva Edison  
1847–1931

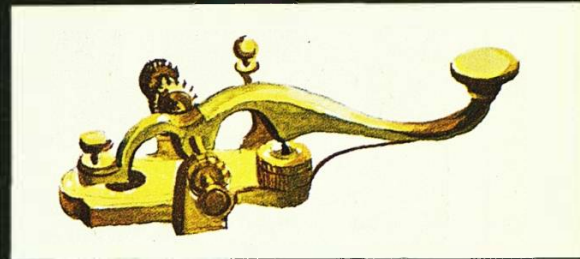

early Morse key

*Below:* Sir Charles  
Wheatstone  
1802–1875

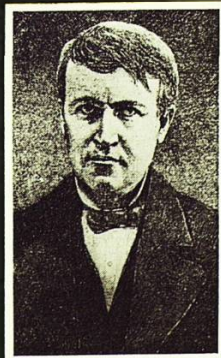

## Section Nine

Photos by courtesy of H.M. Postmaster General

needle  
telegraph

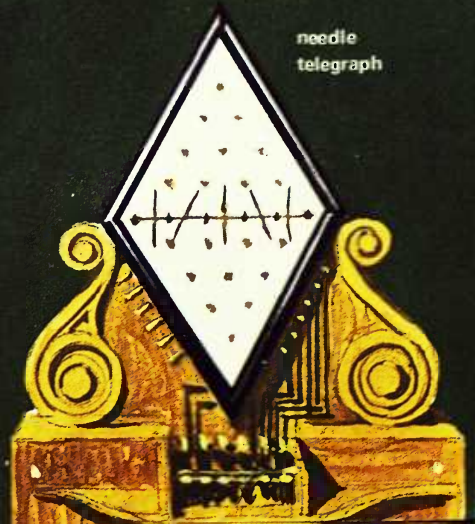



electro-magnets

# MAGNETS

The telegraph and telephone use magnets.

Collect as many different kinds of magnet as you can.

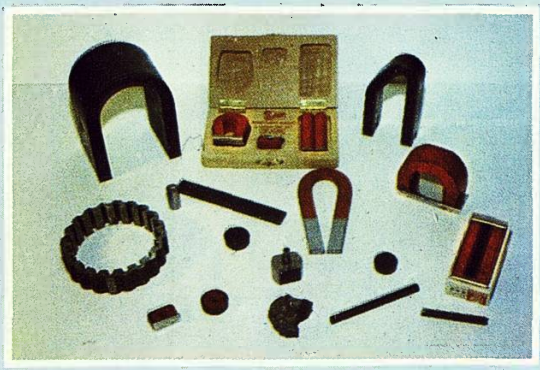

Right: collection of magnets

Which is the strongest magnet?

Here are some children solving this, with their own ideas. They found that small nails called 'panel pins' were most useful.



How many nails are attracted?



How many nails can be hung as a necklace?

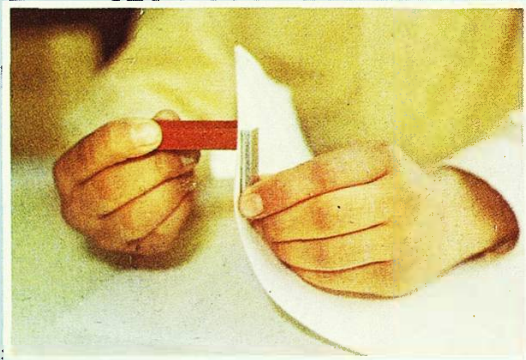

How many sheets of paper will the attraction pass through?



From what distance will the magnet pull the nail?

## Magnetic attraction

Which parts of the magnet attract most? (Will any of the ideas opposite be helpful?)

How far away from the magnet can you find any attraction?

What will this magnetic attraction pass through?

What will a magnet attract?

Investigate with a strong magnet. Record the correct sorting.

You will need a collection of materials to try.

(In your collection try to have samples of steel, iron, copper, brass, tinplate, tin, zinc, lead, bronze, aluminium, nickel, sponge, woods, stone, plastic, chalk, glass, rubber, card, string, etc.)

Before using your magnet try sorting into two sets – one set, those materials you think will be attracted by the magnet; the other set, those that will not.

SET OF  
MATERIALS  
ATTRACTED  
BY A  
MAGNET

SET OF  
MATERIALS  
NOT ATTRACTED  
BY A  
MAGNET

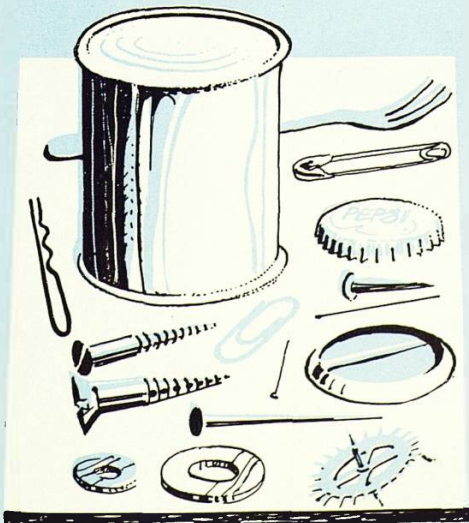

Continue the investigation with a collection of objects. (A suggestion for such a collection is a coin, a drawing pin, different screws and nails, a paper clip, a paper fastener, a school badge, a 'tin' can – in fact any odds and ends you can gather.)

Try your sorting and checking again.

You may have had some surprises, as several things were plated.

(You can find out more about this plating, how and why it is done in *Science in a Topic – Food and Land Transport*.)

# ELECTROMAGNETS

Here is how to wind an electro-magnet:

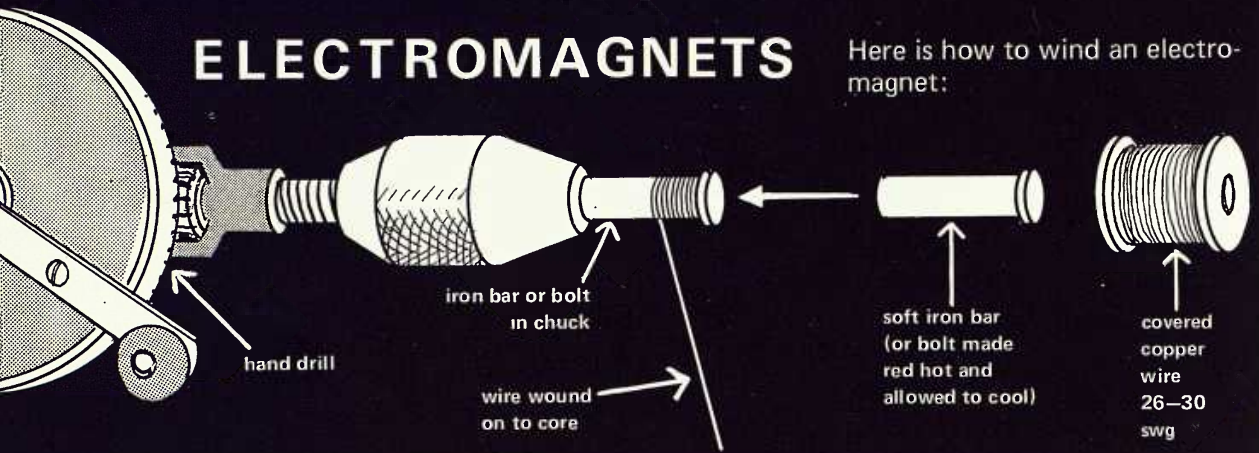

Now connect it into a circuit.

You now have a magnet that you can switch on and off.

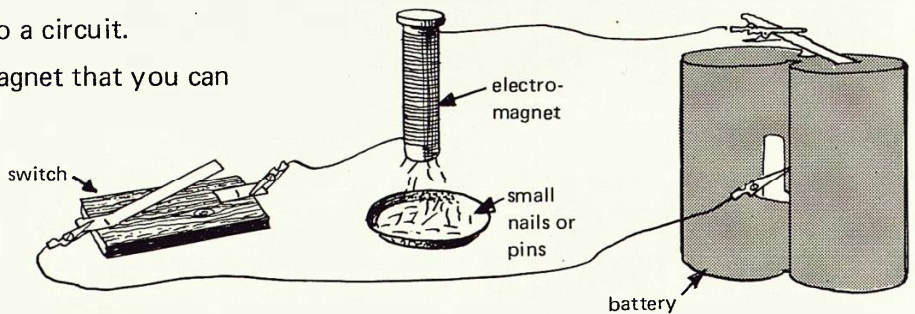

What affects the strength of an electromagnet?

- (a) Does the number of turns of wire affect the strength?
- (b) Does the kind of wire or thickness of wire make any difference?
- (c) Do two batteries give more strength?
  - (i) like this
  - (ii) like this

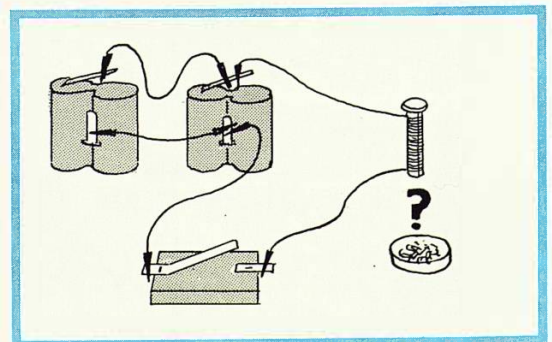
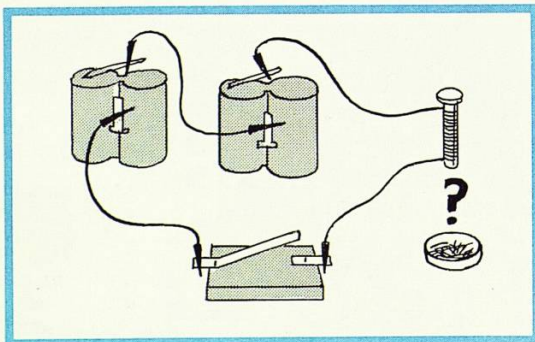

- (d) Does a higher voltage make a stronger magnet?

How will you be able to measure the strength of your electromagnet?  
(Page 44 will give you some ideas.)



This discovery has been used as a method of communication.

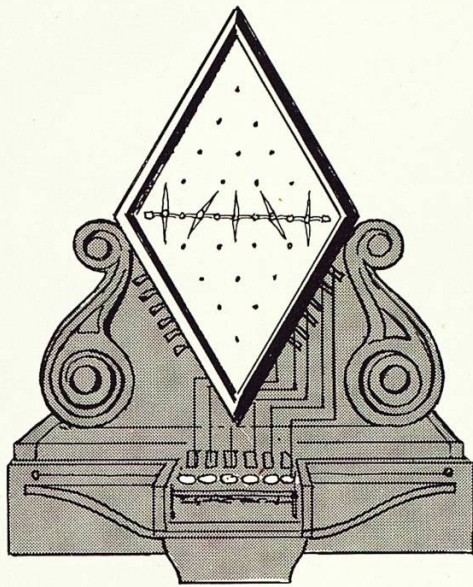

The Cooke and Wheatstone five needle telegraph

Further information about this invention can be found at the Science Museum, South Kensington, London or the Post Office Museum of Telecommunications, 40 Shoe Lane, London, EC4.

## Using Electromagnets

Does it make a difference which way round the battery is connected?

Try this:

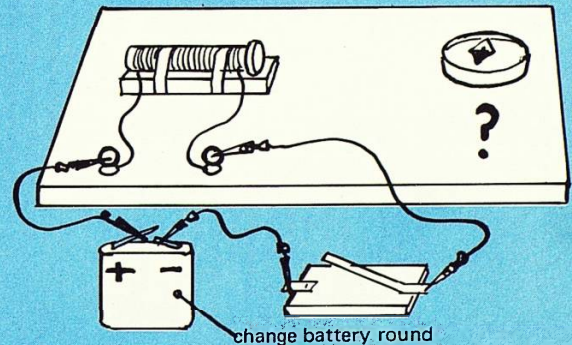
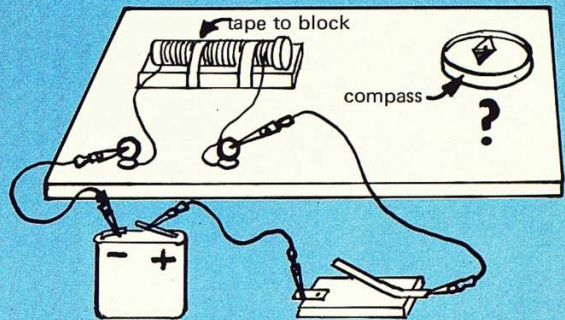

What can you note about the compass needle when the electricity is switched on?

From your experiments you can see that magnetism can be switched on and off by using electricity. This is used in many signalling ideas.

Here are some examples made in one school. The instructions and measurements for these are on the inside covers.

*Right:* A clacker, sounder and buzzer.

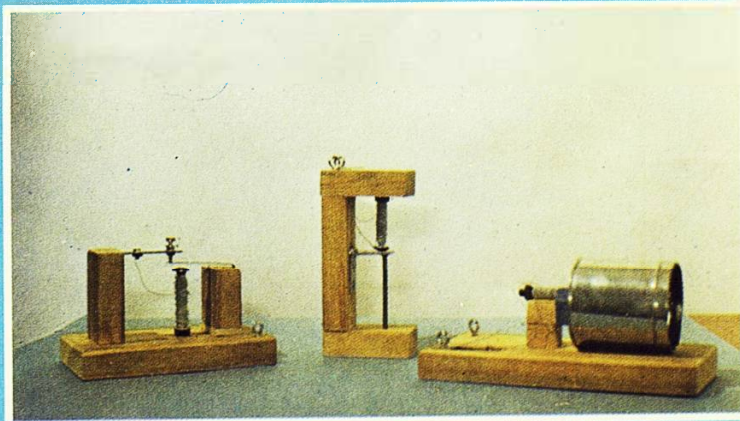

# THE TELEPHONE

You can investigate a simple string telephone on page 16.

Now, find out about real telephones.

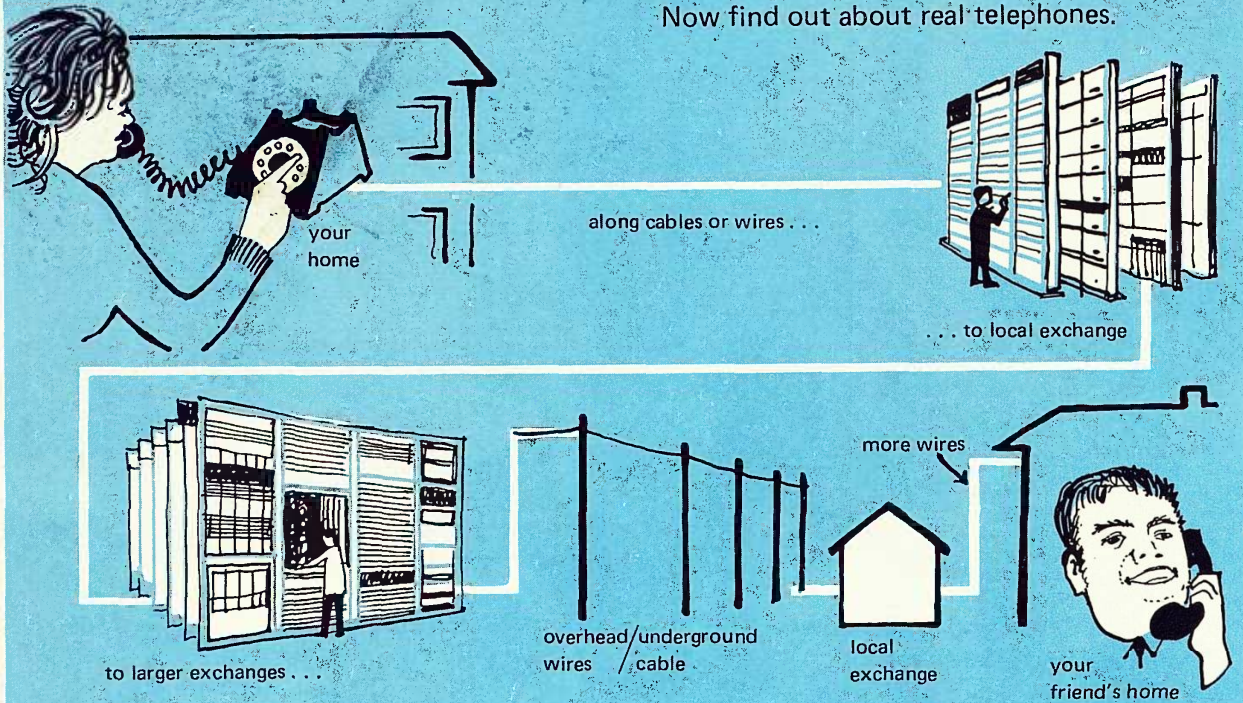

If you can obtain a toy inter-com telephone set, you could rig this between yourself and a neighbouring class and do some valuable speech work.

Try to obtain a 'junk' G.P.O. telephone. Take this to pieces and see what you can discover about the parts.

Let us look at these parts more closely.  
(Turn to back end-paper for a model sounder)

From these investigations and from a study of the above diagram it should be clear that the main parts necessary for a telephone communication are:

- 1 the microphone
- 2 the receiver
- 3 the linking wires
- 4 the telephone exchange.

## MICROPHONE (Transmitter)

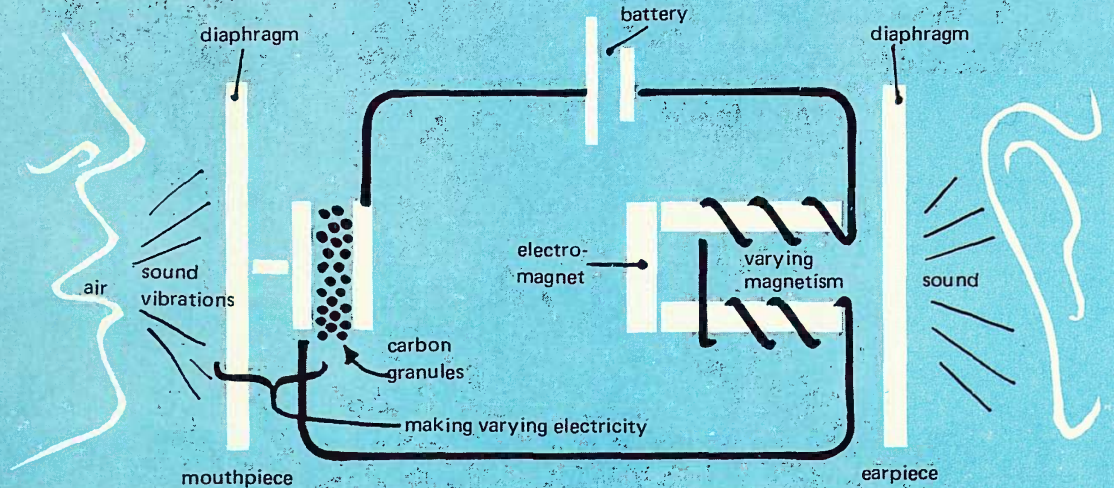

# THE TELEPHONE EXCHANGE

You could make a simplified telephone exchange model.  
This would help you to understand how the real one works.

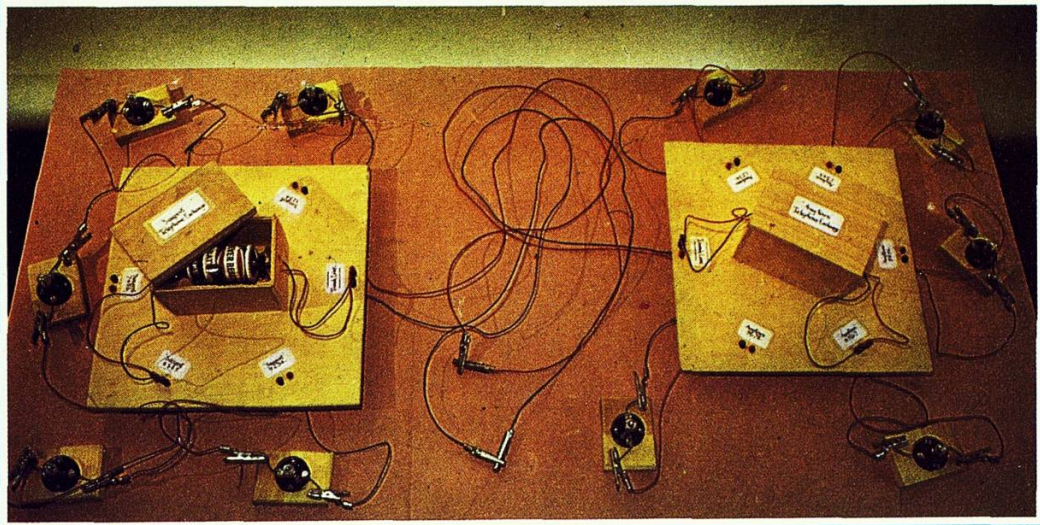

Here is one made by a 'Communication Study' group.

Here are the details of construction:

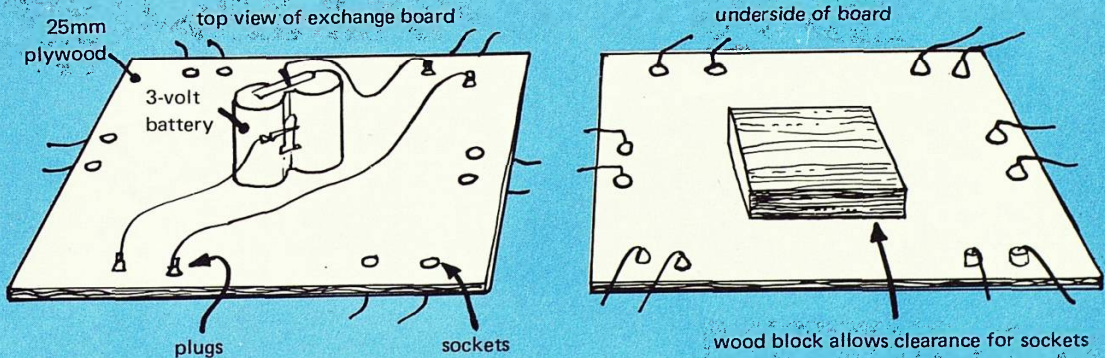

(Lamps were used as it was not possible to gather ten to twelve telephones!) When the lamp lights connection has been made and 'communication' is taking place.

Can you then trace the circuit?

Perhaps your teacher will be able to take you to visit a telephone exchange.



# The Telephone – the linking wires

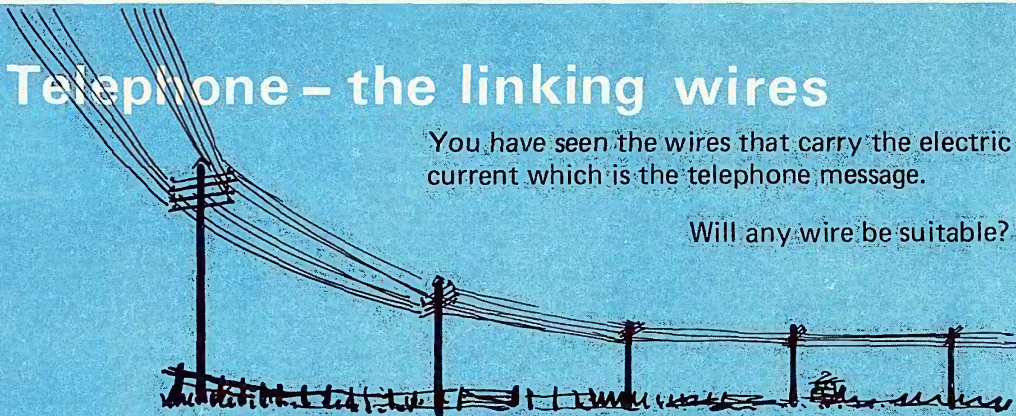

You have seen the wires that carry the electric current which is the telephone message.

Will any wire be suitable?

Does electricity travel differently through different wires?

Does length make a difference?

Does thickness make a difference?

Does the kind of wire make a difference?

A handy way of dealing with these lengths is to wrap and fix them around a piece of board or card, like this:

To help answer these questions use:

$\frac{1}{4}$ m  $\frac{1}{2}$ m 1m and 2m each of

nickel chrome wire 34 swg

nickel chrome wire 26 swg

constantan wire 26 swg

copper wire 26 swg

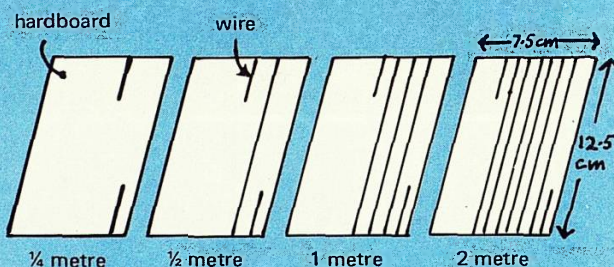

Put your wire into a circuit like this:

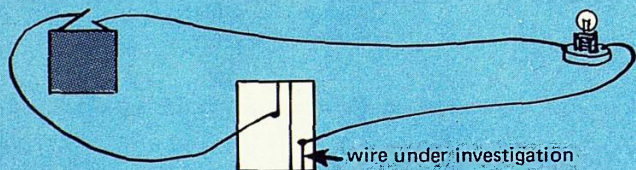

Record your observations

Wire	Observation

Did you find that sometimes it was difficult to notice differences? You will agree that with such observations it is hard to be sure about slight changes.

Can you think of a way to measure the brightness/dimness of the lamps

Here are ways which might help you to measure the brightness of the lamp:

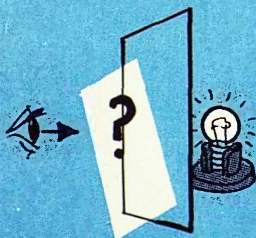

1 Hold coloured papers before a lamp

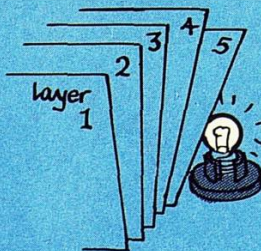

2 Layers of paper until light cannot be seen

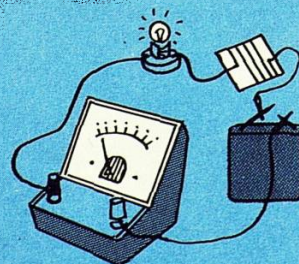

3 Ammeter in a circuit



Multiple images

*Top right:* Fire at night



*Lower right:* Very high speed photography – a playing card sliced by a bullet

*Below:* Earth seen from the Apollo space capsule 21st December 1968

You will see that such photographs can often tell us more than thousands of words.

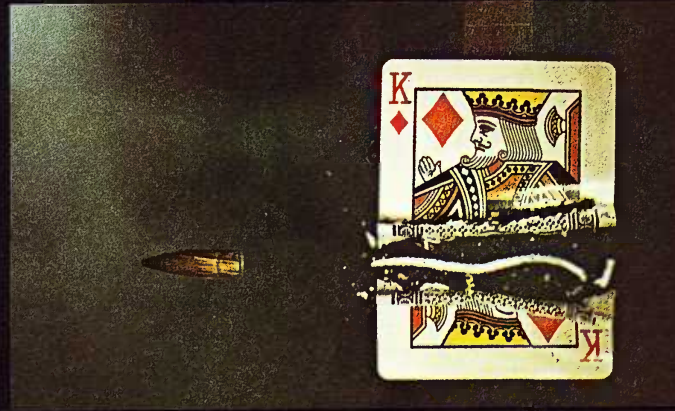

# Photography

Investigate cameras and photography

Can you find:  
Who invented the camera?  
Who discovered the chemistry of developing and fixing a film?  
When the first photograph was taken?  
How films are developed and prints are made?

## Section Ten

# Light Sensitive

Light can change things. For example, have you been tanned or perhaps sunburnt when on holiday? Have you seen curtains or fabrics that have faded?

What other examples can you find where light has caused changes?

You will enjoy experimenting with light sensitive paper.

*Left:* Materials for a photographic investigation — 'Jetline' paper, board, glass or clear plastic, developer and sponge



It can be used like this:

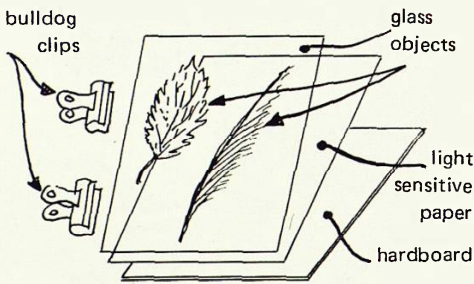

1 Preparation of materials

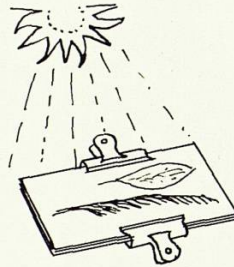

2 Expose to sunlight

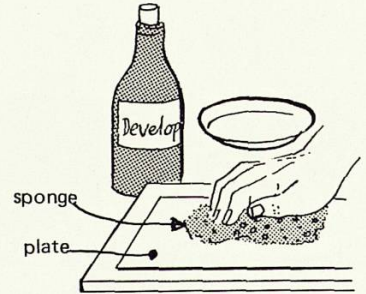

3 Develop and fix

Try 'photographing' leaf shapes, feathers, pressed flowers, lace, leaf skeletons.

You can change the time you allow the light to reach the paper. You could also experiment with the kind of light: daylight, bright sunlight, artificial light and fluorescent light.

This is a useful tool of science. Some children have used it to record how fast leaves grow. They marked and then photographed the same leaf every week throughout the spring.

What other uses can you find for this way of recording?

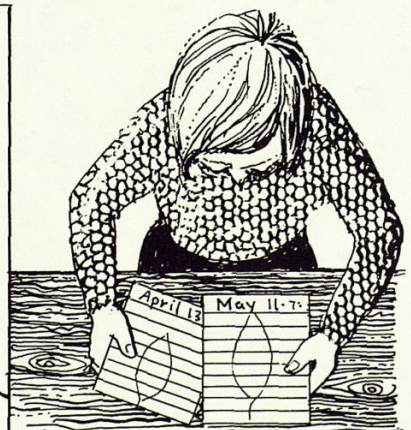
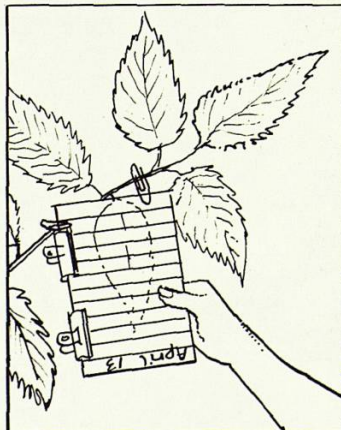

# The Pinhole Camera

This camera has a fixed distance between pinhole and screen.

The simplest of cameras to investigate is the pinhole camera. It is very easy to make. Use a tin with a press-on lid.

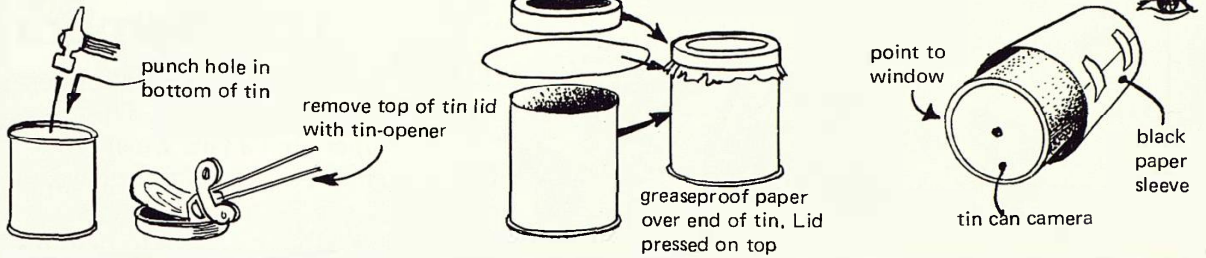

You could make another camera and with this model you can experiment changing the distance.

plan for camera using stiff black card — or use shoe box

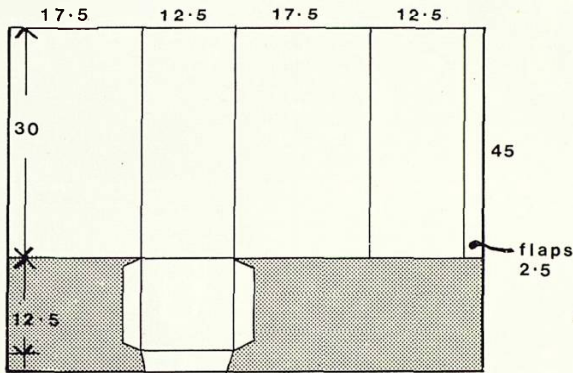

measurements in cm

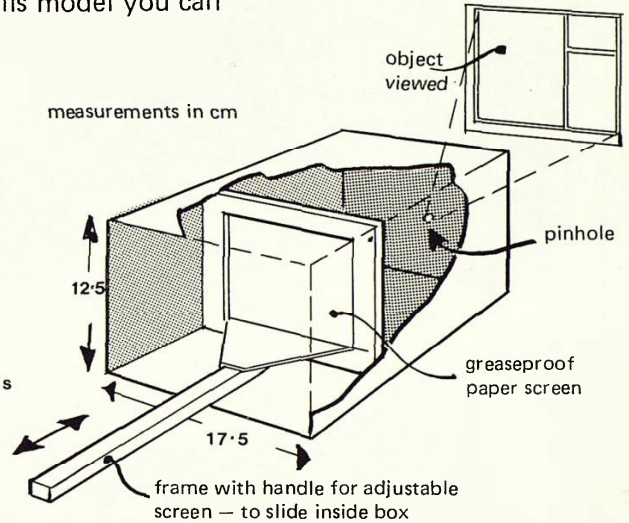

Here is a model with an arrangement for changing the pinhole size or the number of pinholes

plan for camera using stiff black card — or use shoe box  
measurements in cm

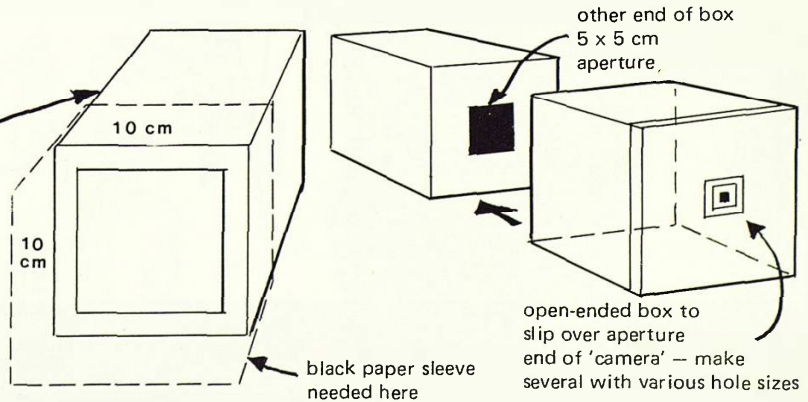
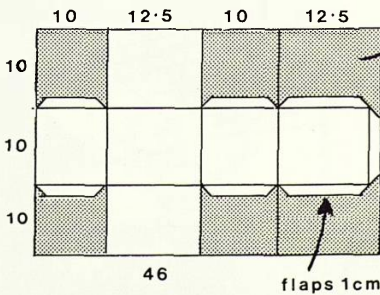

What difference does the size of the hole make?

Distance of pinhole to screen	Actual window size	Picture size	Observations on the brightness and sharpness of the picture

What happens if there are two . . . three . . . holes?

Size of holes	Observations	Number of holes	Observations

Record your observations — for example, viewing a window

# The Camera

You can see that a real camera is very complicated. This camera has a lens which your pinhole model did not have. This is the main difference. The other parts are to help the photographer to control the light.

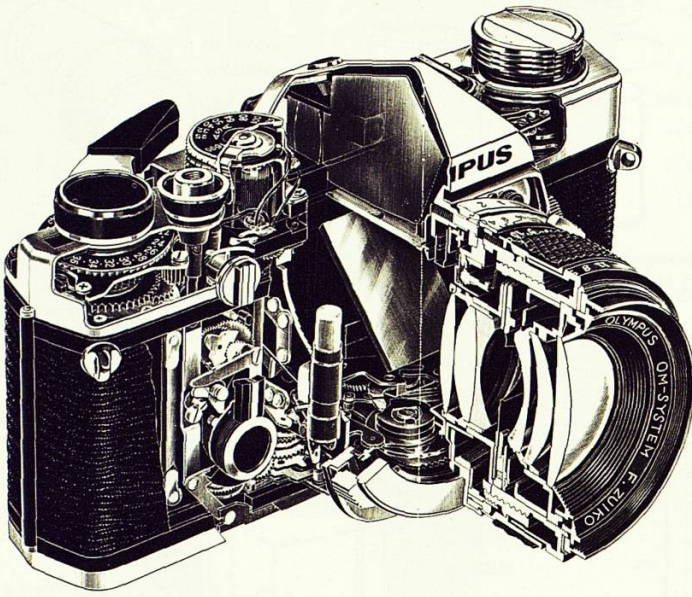

*Left:* The Olympus OM-1 camera — a modern camera showing the complicated mechanism

What does a lens do? Try this:

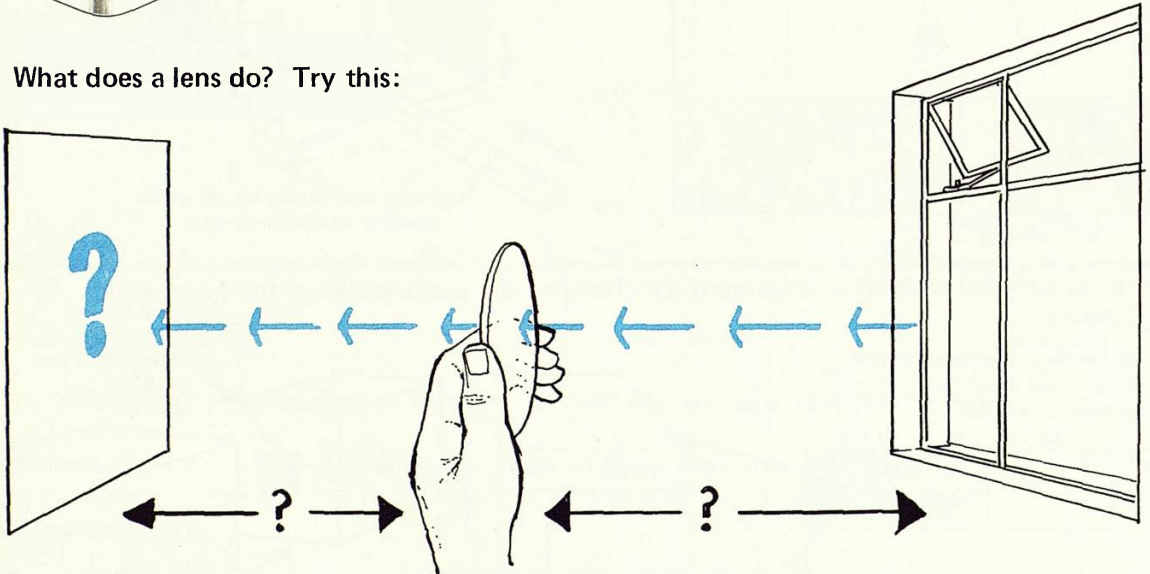

Some of you will have a camera of your own. Experiment with this.

- Find out what happens when you vary the time of exposure.
- What happens if you vary the 'f' number (size of the hole letting light into the camera)?  
Look particularly at what parts of the picture are sharp and clear.
- Try photographing movement, towards and across your camera.
- Try the effect of 'panning' (swinging your camera with the line of movement).
- Discuss your picture composition.

Why not take a picture record of some of your communication study and add a commentary using your tape recorder?





Marconi and his transmitter — 1902  
Right: Policeman using walkie-talkie

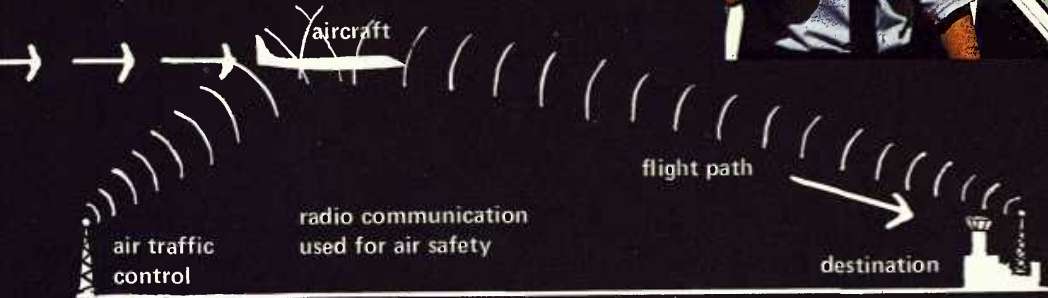

# Radio and Television

## Section Eleven

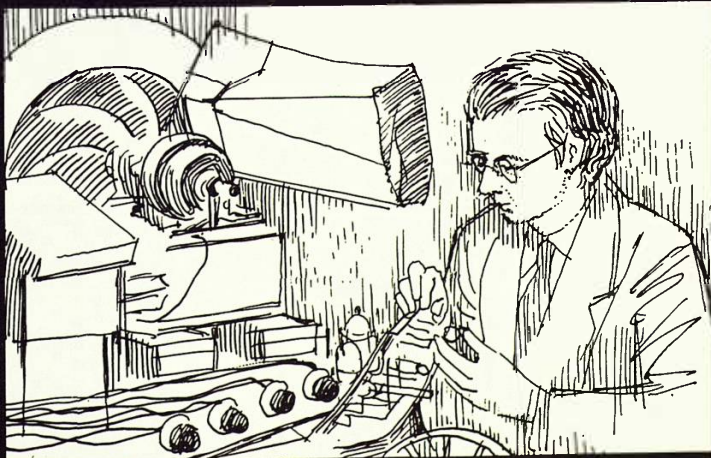

John Logie Baird working on his transmitter — 1925

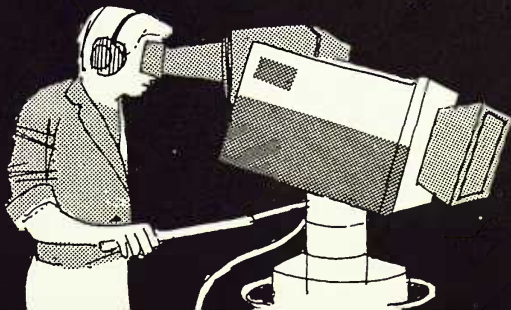

Left: A studio television camera

Right: G.P.O. Tower, London transmits many television programmes

What did Marconi and Baird contribute to radio and television?

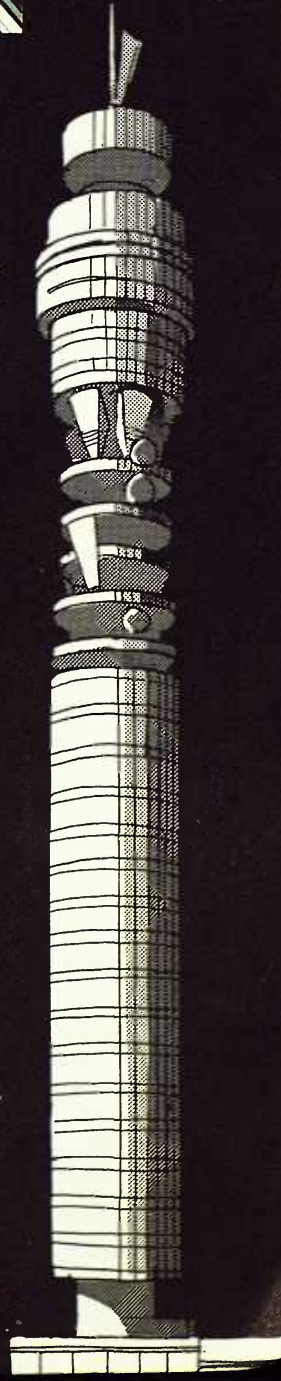

# Radio-How it works

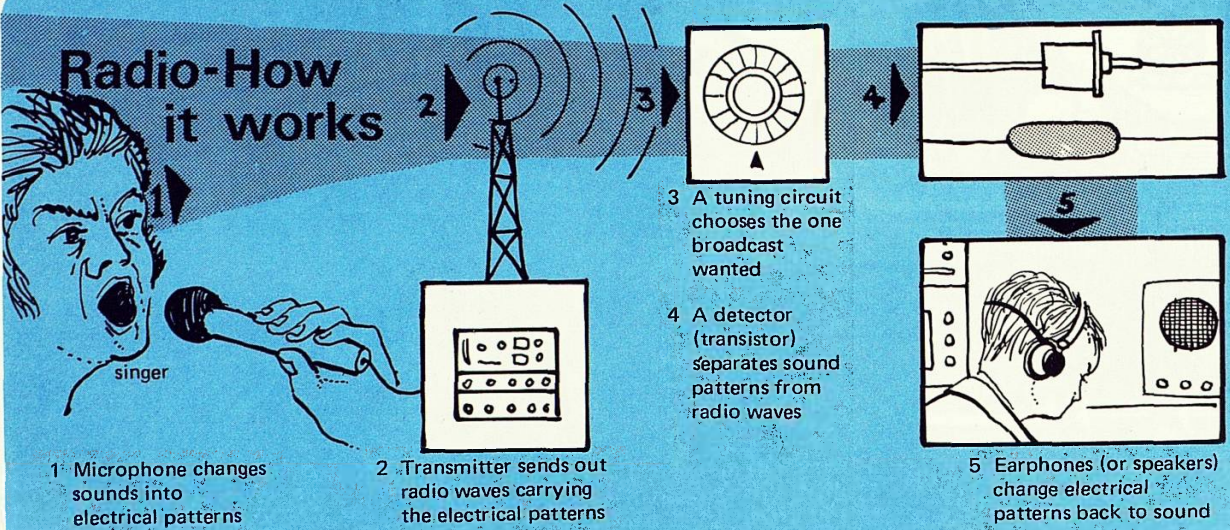

1 Microphone changes sounds into electrical patterns

2 Transmitter sends out radio waves carrying the electrical patterns

3 A tuning circuit chooses the one broadcast wanted

4 A detector (transistor) separates sound patterns from radio waves

5 Earphones (or speakers) change electrical patterns back to sound

A very important part of a radio is the **DETECTOR**. This sorts the electrical 'sound' patterns from the radio waves.

The first radios used a crystal as the detector.

In 1904 Ambrose Fleming invented the **VALVE**.

In modern radios **TRANSISTORS** are used.

A simple radio that you could build uses a tiny piece of equipment called a **crystal diode**.

These are not expensive and can be obtained from any radio spares shop.

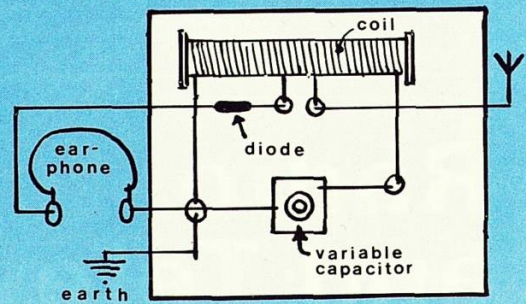
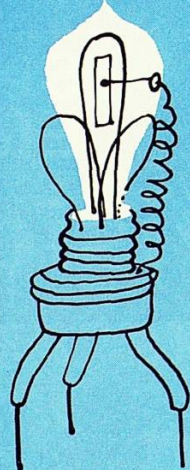

Above: A crystal radio receiver  
 Left: Ambrose Fleming's diode valve  
 Below: Some modern transistors

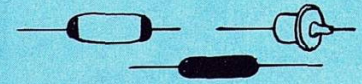

## Experiment with a diode:

- 1 Put a diode into a circuit
- 2 Reverse the diode in same circuit
- 3 Try two diodes in one circuit

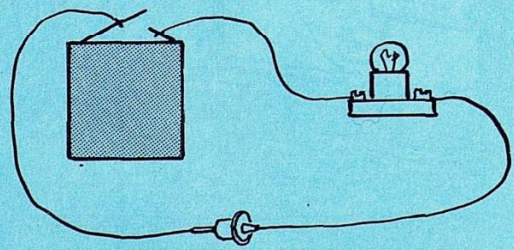
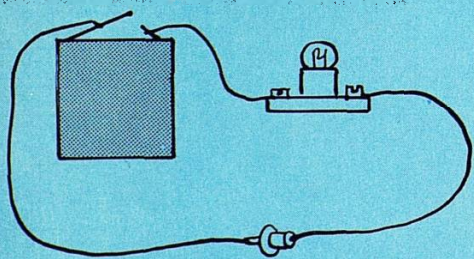

Describe what happens in each case

This experiment you have tried is the beginning of a vast study called **electronics**. This can become a lifetime hobby or study.

A few simple things can receive radio communication:

# BUILDING A RADIO

- 1 An aerial and earth (A coil and condenser improve this.)
- 2 A diode (The detector – see the previous page.)
- 3 An earpiece (This changes the electrical patterns to sound.)

Try building a simple radio with the following materials

You will need:	Ask at your radio spares shop for:
aerial wire	an inexpensive plastic-covered copper wire (30 m)
earth wire	any bared wire – twist it round a water-pipe
crystal diode	OA81 or OA91
capacitor	a compression trimmer 100 to 500 pF
coil	DRX1 – or wind your own. 50 turns of 26 or 30 swg insulated copper wire on a ferrite rod
earpiece	or headphones
plugs/sockets	Wander plugs      single sockets
resistor	4.7 kohms

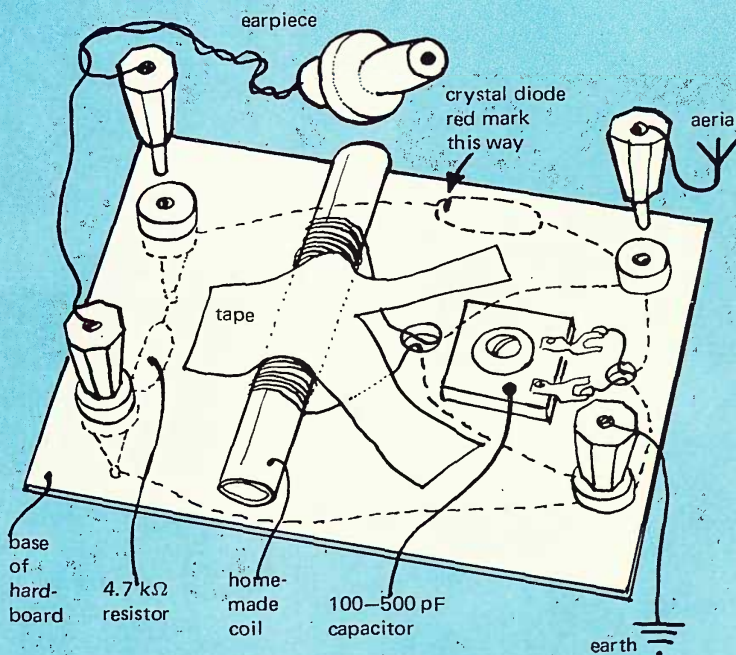

Put the pieces together like this:

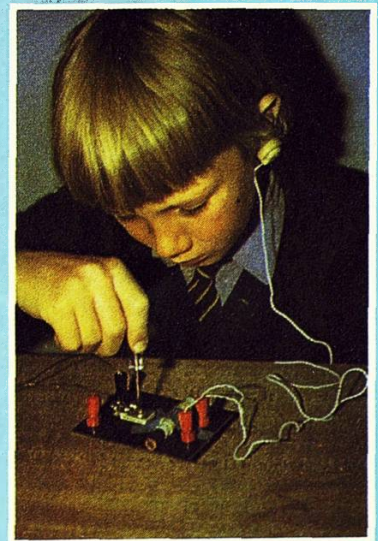

Listen with your earpiece and turn the variable capacitor very slowly. You will have to listen very hard, as with such simple equipment the signal will be very faint. (An improved radio construction is shown on the front inside cover)

# Television

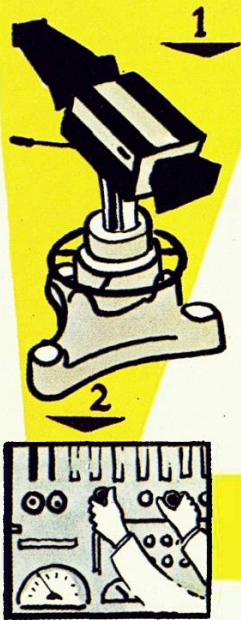

- 1 Camera in studio
- 2 Amplifier (signal made stronger)
- 3 Producer selects in control room
- 4 Transmitter (waves carry signal)
- 5 Receiving aerial
- 6 Receiving apparatus (T.V. set)

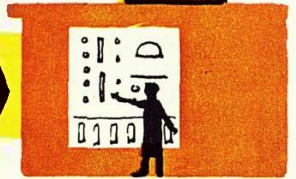

The T.V. picture is actually a beam of electrons making a light spot which scans the screen very rapidly.

The moving spot builds a picture that appears to be there all the time. A new picture is 'drawn' every fiftieth of a second. Our eye keeps one picture until the next comes.

If you move your hand across the T.V. screen like this you will see your hand is lit up in different positions.

Try moving your hand at different speeds.

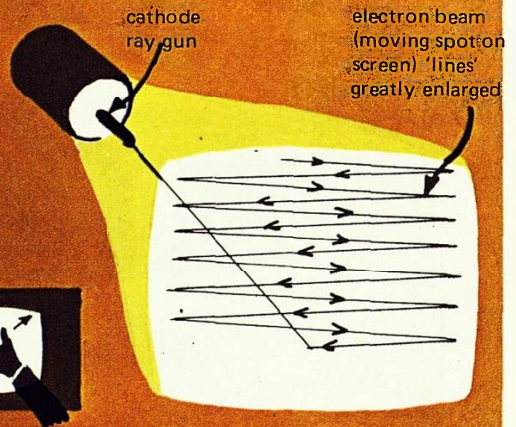

You can get some idea of how our eyes hold on to a picture by trying these experiments.

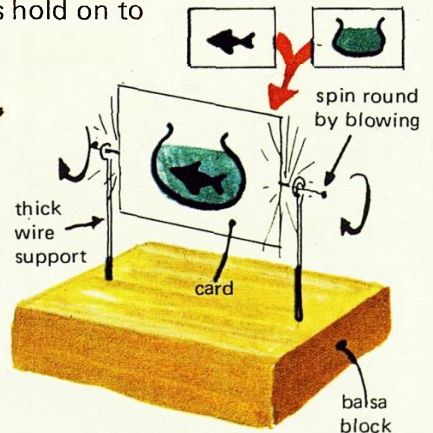
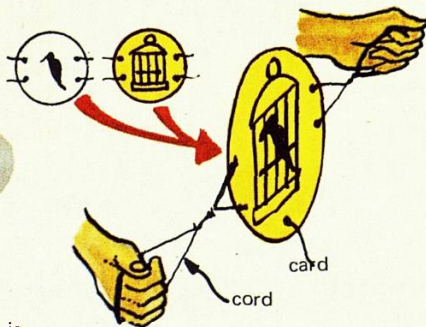
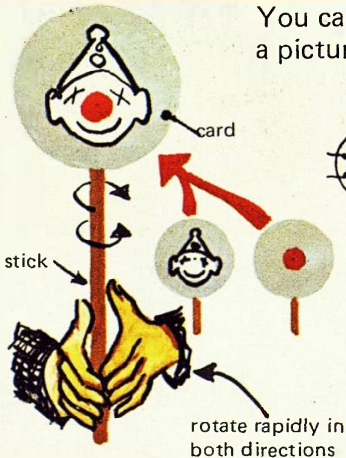



# Animal Communication

## Section Twelve



The peacock has opened its feathers in a magnificent display. Why?  
How does the toad communicate?

What messages are these and other animals communicating? See if you can find out how and why animals need to communicate. Can people and animals communicate with each other? How?

# Pets Communicating

You could do some research with your own pets.

How many of your class have a dog or a cat as a pet?

Record how the dog or cat communicates with its owner.

For example: 'Let me out'  
'Feed me'  
'Play with me'  
'Keep away'  
'Let me in'

How is this done? Have you noticed from your recording which animal can 'say' more — the dog or cat?

In the wild, dogs hunt in packs but cats do not. Could this have anything to do with their communication patterns?

How do dogs communicate with each other?

Look at their tail positions carefully.

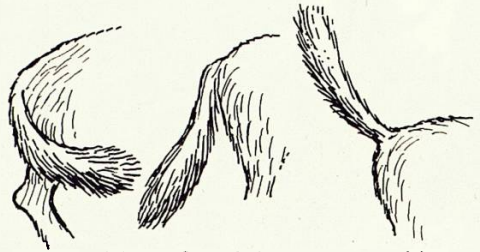

Left to right: Submission; normal position; confidence

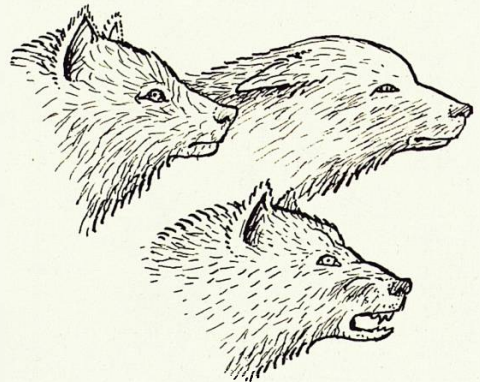

Left: Normal Right: Fearful  
Below: Aggressive



Some dogs are specially trained. Communication must take place between trainer and dog. Find out about this training.

It may be possible to invite to school a dog-trainer, a police dog-handler and his dog or a guide-dog and its blind owner.

Left: A guide-dog taking its blind owner across the road

# Birds Communicating

How well do birds communicate?

You probably know something of the way birds sing. They do this to show their right to a territory. Their song is 'saying', 'I am here — there will only be enough food for me and my family — keep away.'

Find out more about bird song. (A tape recorder will help.)

- (a) When do the various birds sing?
- (b) Where do they sing? Is it always the same place or the same sort of place?
- (c) How long do the various kinds sing for?
- (d) Do different birds sing at different heights?
- (e) Which birds start and which finish 'the dawn chorus'?

Birds do not only communicate by song. Head, neck and wings are all used to communicate. Wild fowl can make an interesting study. Threat displays, courtship displays can be 'read' clearly if you watch them carefully.

Here are some such conversations:



These geese are having an argument. Each goose stretches up his neck and gradually lowers it as he runs towards the other. The intruder usually goes away and this avoids a fight. If you can ever visit a wildfowl reserve you will be able to see for yourself.

penguins greet each other

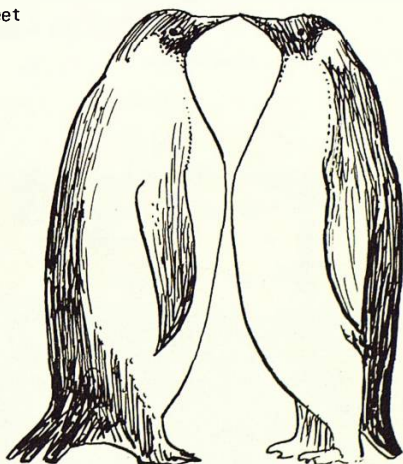

young birds are communicating in yet another way!

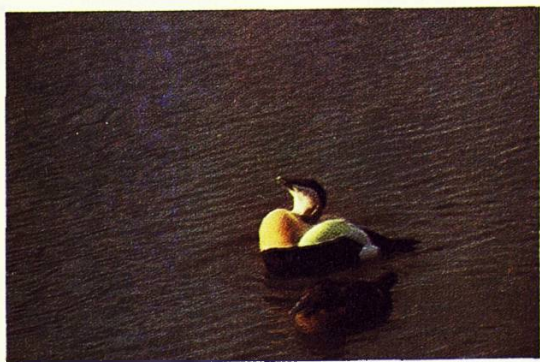

Common eider-duck courtship. The female is in front.

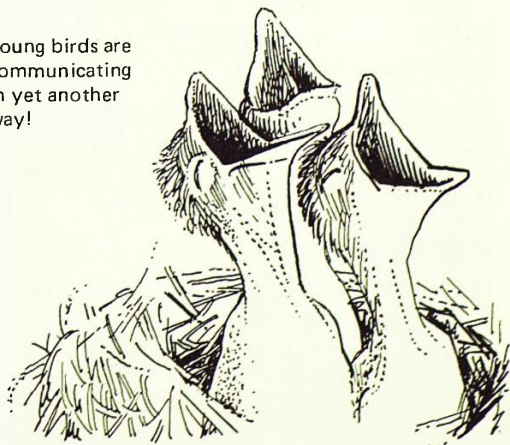

The scientist who tells us so much about animal communication is Konrad Lorenz. Try to read his book *King Solomon's Ring*.

# Bees Communicating

Can insects communicate?

Karl von Frisch's work with bees makes fascinating reading. Do try to read how he discovered the language of the bees.

He discovered that a returning bee can communicate to the rest of the hive. This bee can show others how far away the food is and in which direction it is.

This is done by a certain dance movement.

If your school can obtain an observation hive you can see this for yourself.

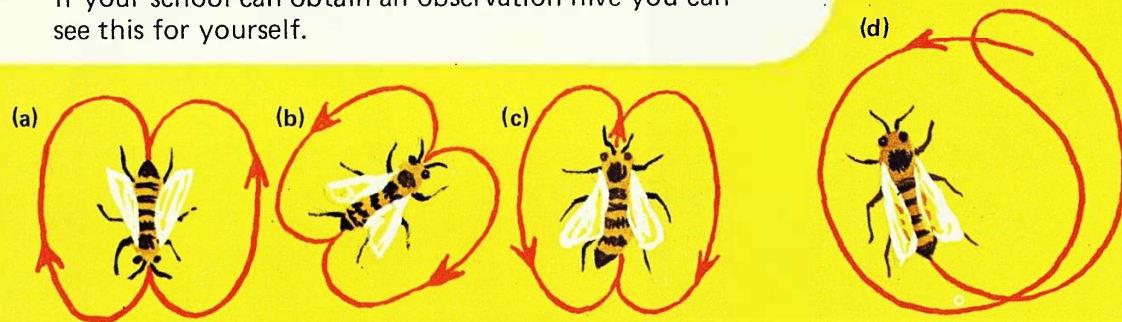

(a) indicates direction and distance of food

(b) at an angle to the sun by the direction shown  
(d) food close to hive

(c) 'waggle' dance

Put out some sugar solution on some coloured paper flowers.

Watch — which one attracts most bees?

Observe the return to the hive.

Do the other bees find the food?

Do they go back to the same 'flower'?

Can this mean that more information is given than 'which way' and 'how far'?

Can other insects communicate?

Ants are worth studying.

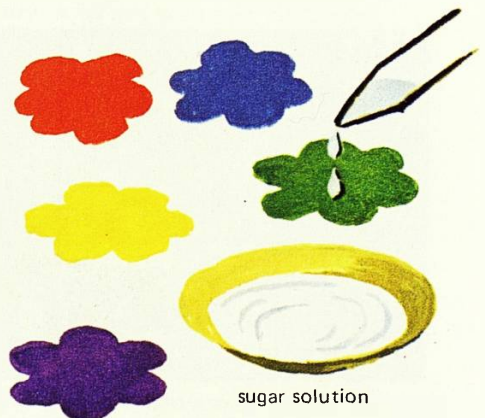





## Colour and Communication

Many animals use colour to communicate:

'Keep away — I am poisonous!'

'Stay away — I taste bad!'

Study some of the colours of such animals as snakes, wasps, scorpions, skunks and porcupines. What unpleasant experiences do these animals have in store for any attackers?

These bright colours are often warning colours and mean the wearers can defend themselves by sting, bad taste, bad smell or poison.

*Above:* A peacock butterfly

*Below:* A fire salamander



# An Integrated Study of Communication

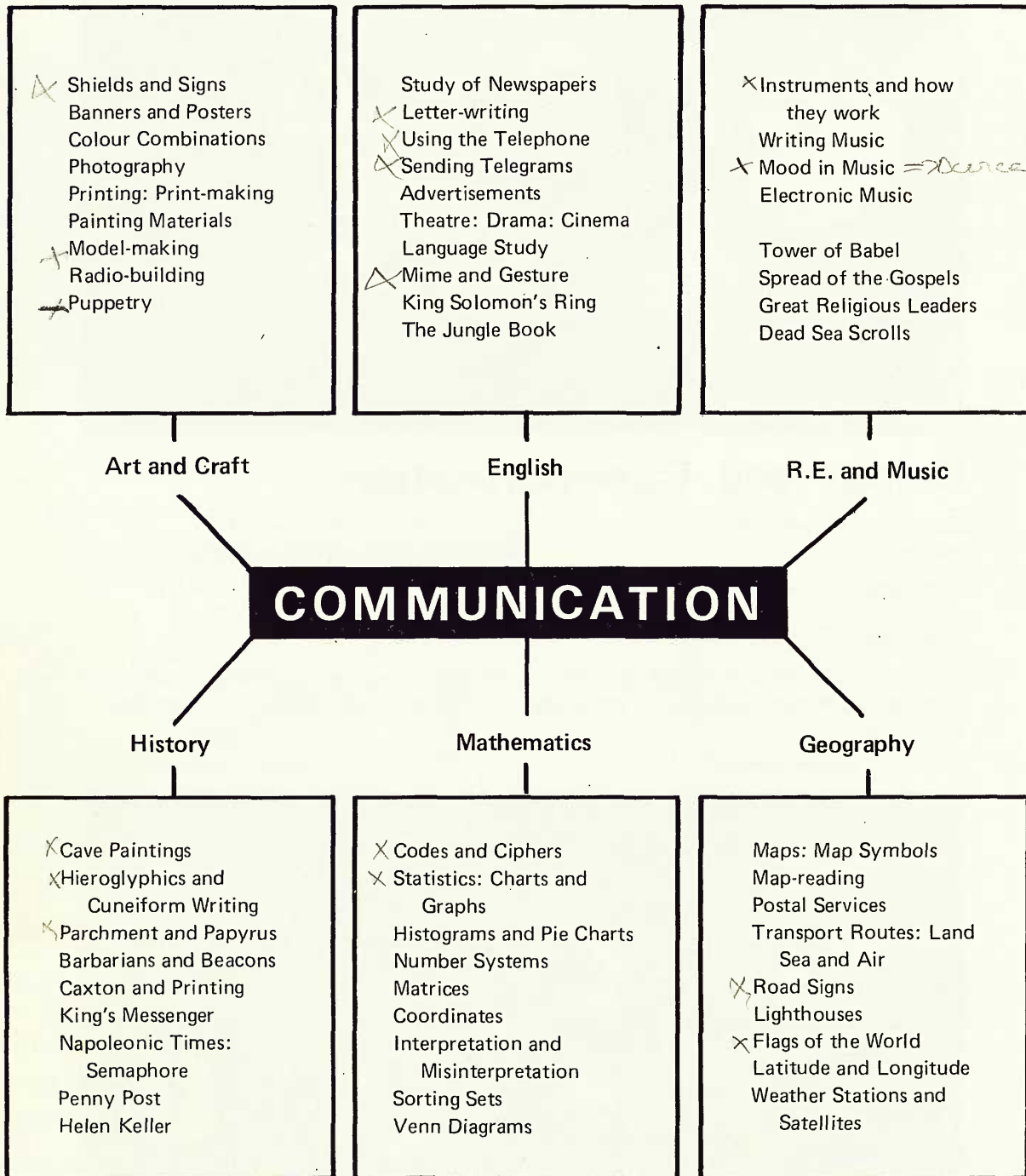

## Acknowledgements

The authors are grateful to the following for permission to reproduce copyright photographs:

David Williams (Cine Equipment) Ltd.; Eastman Kodak and Kodak Ltd.; The Guide Dogs for the Blind Association; Mrs. Ursula Bowen, Head of Sciences Department, The Lady Spencer-Churchill College of Education; N.A.S.A.; J. Allan Cash Ltd.; Edward Ashpole; Heather Angel; Thames Valley Police; H.M. Postmaster General. Permission to reproduce postage stamps was granted by the Post Office.

Thanks are due to the following for help with research:

The Science Museum; The Post Office Museum of Telecommunications; Times Newspapers Ltd.; Amplivox Hearing Aid Museum.

# Model Making—some sound-makers

## A 'sunder'

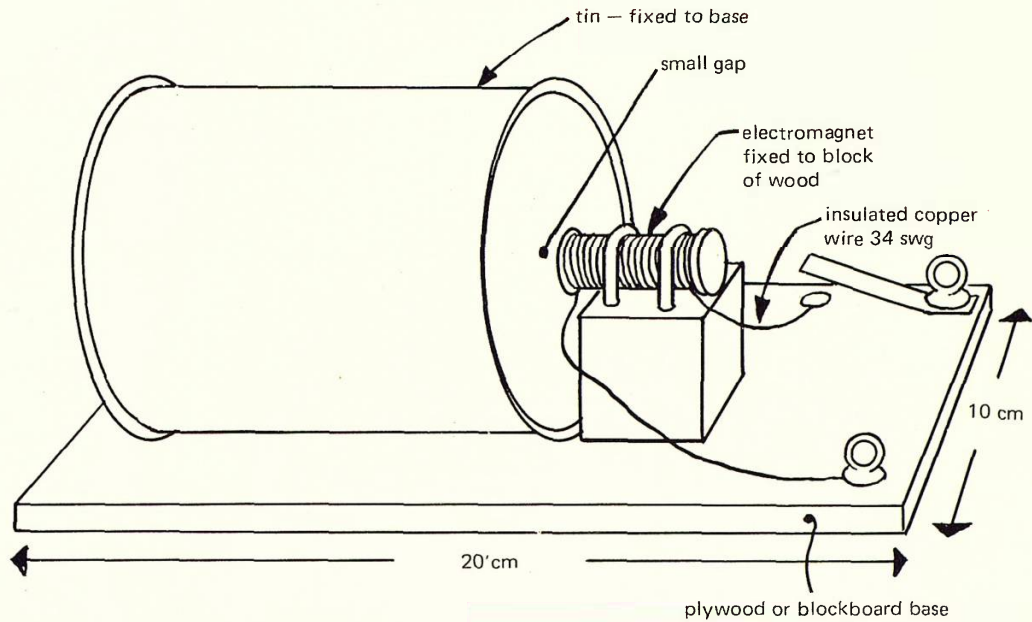

## A 'buzzer'

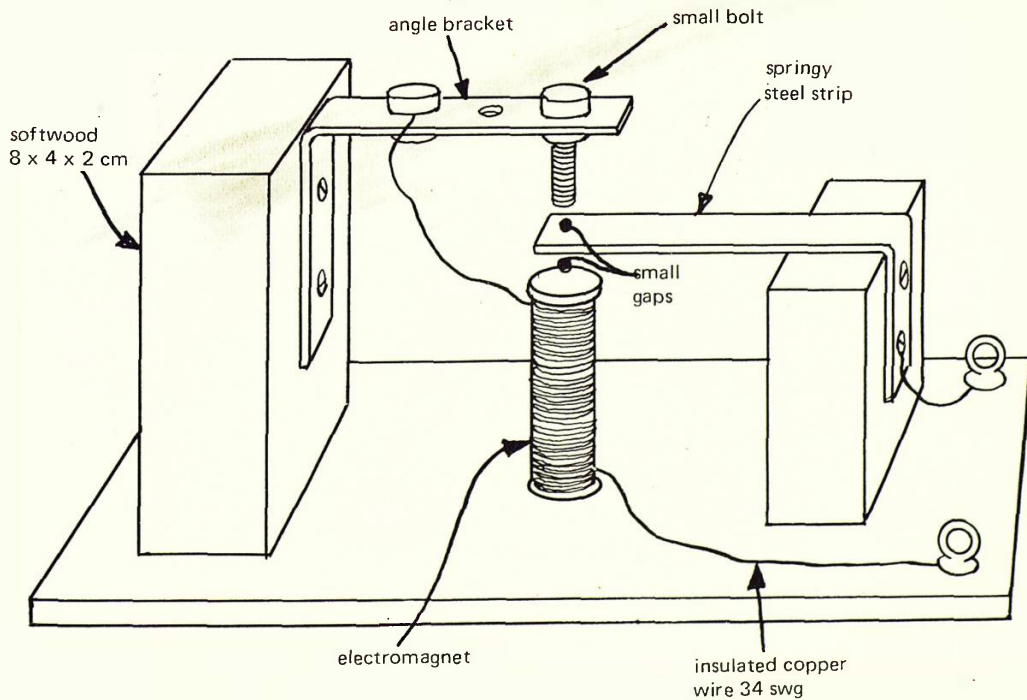



# THE LIFE OF

SCIENCE IN A TOPIC – COMMUNICATION

ISBN 0 7175 0753 X