

The Heart Pacemaker

Contents: Reading, questions and discussion concerning electronic heart pacemakers and their use in treating heart defects.

Time: 1 to 2 periods.

Intended use: GCSE Biology and Integrated Science. Links with work on the heart and circulation of the blood, and applications of electronics.

Aims:

- To complement and revise work on the heart and circulation of the blood
- To show an important application of electronics in medicine
- To develop awareness of the ways science and technology can be used to improve the quality of people's lives
- To provide opportunities to practise skills in reading, comprehension and the application of knowledge.

Requirements: Students' worksheets No. 603

Background notes on heart pacemakers

Pacemakers are required when the natural pacemaker and the normal electrical conductivity tissue of the heart are damaged through ageing or failure of the blood supply (anoxia).

There are two types of pacemaker. The *Fixed-rate Pacemaker* puts out electrical impulses continuously at one pre-set rate, whether or not the heart is beating on its own. Its pulse generator does not sense the natural heartbeat, and the pacemaker overrides it. The *Demand Pacemaker* is more common. It senses the heart's natural rhythm, emitting pulses to stimulate the heart only when the natural rhythm falls below the pulse generator's set rate. Thus the Demand Pacemaker only works when it is needed — when the natural heartbeats are absent or too slow. This pacemaker can be either non-programmable (that is, its rate and other parameters cannot be changed), or programmable. A programmable pacemaker allows the doctor to alter the pulse generator's operation to fit changes in the patient's needs. This is done using an electronic programmer which transmits at radio frequency and is held on the patient's chest, over the implanted pacemaker unit.

A typical pacemaker might measure $5\text{cm} \times 5\text{cm} \times 1\text{cm}$ and weigh about 50g. The case material is titanium, with a coating of silicone rubber.

Most pacemakers are powered by batteries such as lithium-iodide or mercury-zinc cells. Nuclear power sources can also be used. These involve a tiny plutonium source generating heat and warming a stack of thermocouples to produce electricity.

A simple electronic pulsing circuit

The circuit below demonstrates how regular pulses of current can be generated. Some students might like to try building it. By varying the resistor, the rate of flashing of the light can be speeded up or slowed down. This is comparable with variation of heart rate at rest and during exercise.

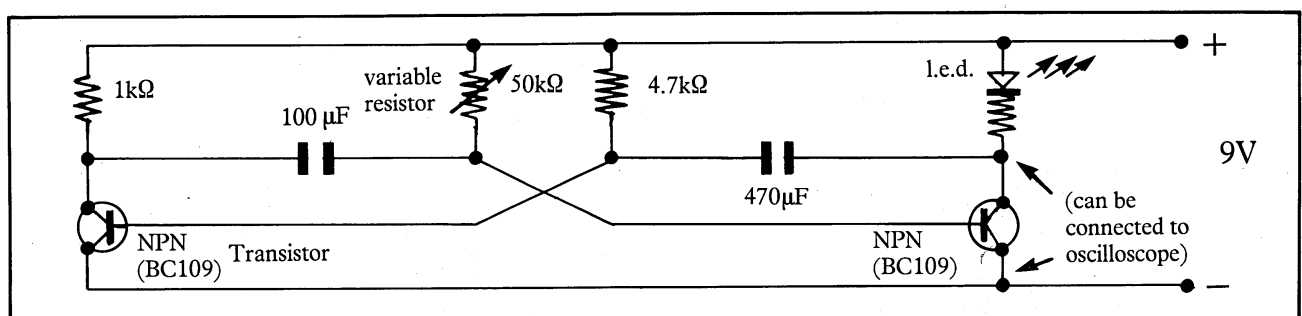

Notes on some of the questions

Q.5 By fitting the pacemaker unit on the front of the chest, major surgery can be avoided. It also makes it easier to service the unit and change the batteries.

Q.9 The figures are taken from Davidson's *Principles and Practice of Medicine*. They raise the difficult question of whether it is justifiable to devote resources to the treatment of diseases which it is within many people's own control to avoid in the first place. The same question arises in the case of diseases related to smoking and drug abuse. Heart disease treatment makes particularly heavy demands on resources, needing highly qualified staff and expensive equipment. On average there is one nurse to every two patients in a coronary care ward, compared with one to every six or seven patients in a normal ward.

Q.10 There are many examples. Kidney machines, body scanners, radiotherapy and spare part surgery might all be mentioned.

Acknowledgements Figure 2 is reproduced by courtesy of Bill Wheat; Figure 3 is reproduced by permission from *Science* by Graham Hill and John Holman (Nelson); Figure 7 supplied by Medtronic Pacing Products; Figure 8 reproduced by permission from *Medtronic Currents: an Overview of Pacing*.

THE HEART PACEMAKER

Do you know a person who has been fitted with a heart pacemaker? It is quite possible that you do, because around 400 000 are fitted every year throughout the world.

Pacemakers are fitted to people whose hearts do not beat regularly. Before pacemakers were developed, these patients could not expect to live long, as you can see from the graph in Figure 1. For tens of thousands of people it means the difference between death and a normal, active life.

The heart pacemaker is an artificial heart stimulator. It sends small electric pulses to the heart to make it beat regularly. It is fitted when the normal, healthy rhythms of the heart have been disturbed. In most cases a patient needs the pacemaker for the rest of his or her life.

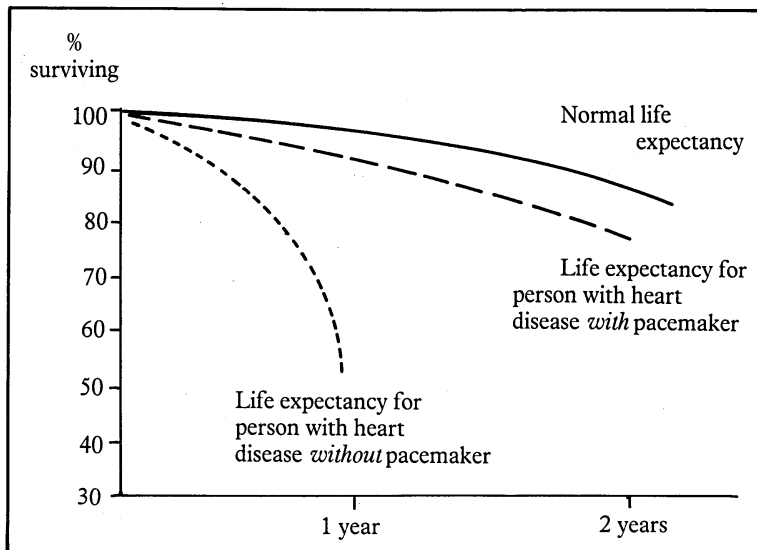

Figure 1 How a heart pacemaker increases life expectancy

Living with a pacemaker

Bill Wheat is 77 years old and lives near Walsall in the West Midlands. He still works in his own florist's business and enjoys life to the full. He was fitted with a heart pacemaker about two years ago. We met him one lunch-time at his local pub. He talked enthusiastically about his pacemaker and how it has affected his life.

We first asked Bill how he felt before he had the pacemaker fitted.

'Well, mine was an unusual case because I wasn't aware that I had a heart condition. I'd been involved in a car accident and was in hospital recovering from an operation. I was feeling tired and getting out of breath from the slightest activity. I thought this was due to the accident and through trying to do too much — I'm not as young as I used to be! When you've always been active like me it's very difficult to accept getting out of breath and having to take regular rests after doing little jobs or even just walking around. The doctor in the hospital decided to do some tests on my heart and found that it was not functioning efficiently. That was the cause of my tiredness and breathlessness.'



Figure 2 Bill Wheat

'How did you feel about having a pacemaker fitted?'

'Well, at first I was a little worried but I remember talking to the chap in the next bed who had been using a pacemaker for five years. He said it was marvellous and that he could run up and down hills! He also said that last week when he found he couldn't run up the hill as fast as normal he knew that his battery must be running down and he was in now to have it changed! After talking to him for a while he cheered me up no end and I realised how beneficial pacemakers could be.'

'What was it like having it fitted?'

'I think I could best describe it as being a little worse than having a tooth pulled. It was a local anaesthetic and they gave me three injections just below my right shoulder. After that I hardly felt a thing. The doctor made a small cut just below my right shoulder and introduced the lead into a vein. It was fed down through the vein into the heart itself. You can lie there and watch it on a television screen. A cut was next made in the right upper part of my chest and the pacemaker unit was implanted under the skin and the lead was attached.'

Bill then showed where the pacemaker was fitted and it was possible to feel its outline under his skin. You couldn't tell by looking that he had a pacemaker fitted.

'How has the pacemaker affected your life?'

'It's absolutely marvellous. Of course I'm still working and I do take it easy — I have to pace myself. But you feel like living and you feel good to be alive. I can now feel my pulse beating in the tips of my fingers. I can continue to live a normal active life for a man of my age, thanks to the pacemaker.'

Before looking a little more closely at pacemakers, let's see how the heart itself works.

How does the heart work?

The heart is a muscular organ about the size of a fist. It pumps freshly oxygenated blood from the lungs to the body's tissues, so that they can survive and do work. Carbon dioxide is returned in the blood to the lungs where it is breathed out.

The heart-beat rate changes with demand. Exercise causes the heart to beat faster as more oxygen is needed. Rest means the heart can beat more slowly.

Figure 3 shows the structure of the heart. The right side of the heart collects blood from the body and sends it to the lungs. The left side collects oxygenated blood from the lungs and sends it to the body. On each circuit of the body, therefore, the blood passes through the heart twice. The two atria beat first, then the ventricles. The heart beats 60 to 100 times a minute at rest — over 100 000 times a day. It sends the equivalent of 8000 litres of blood a day through the system.

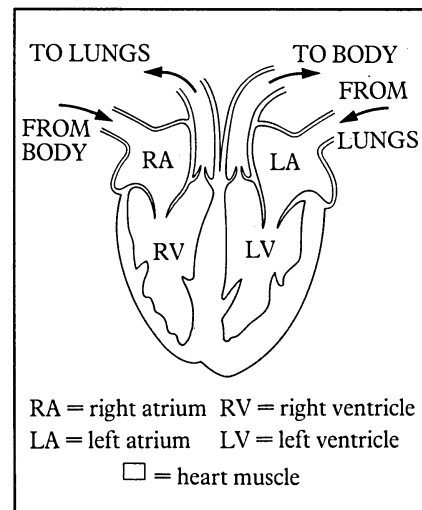

Figure 3 The structure of the heart

The beating of the heart is controlled by a 'natural pacemaker'. This sends a wave of electrical impulses through the heart (Figure 4). These impulses pass first through the two atria, causing them to contract. This squeezes the blood through valves into the two ventricles. After a short delay, the electrical impulses pass into the ventricles. This makes the ventricles contract and squeeze the blood into the lungs or the body. The rate of heart beat can be increased by sending messages from the brain along nerves to the natural pacemaker.

Occasionally something goes wrong with the natural pacemaker or the conduction pathways which carry the electrical impulses. The heart rate then becomes very slow or even stops. A slow heart rate leads to dizziness, drowsiness or shortage of breath. This is where an electronic pacemaker can take over the function of the natural pacemaker.

Answer questions 1 to 4.

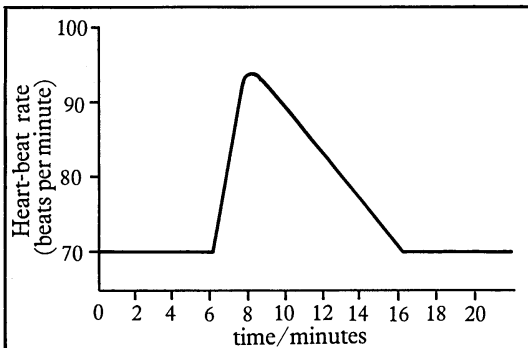

Figure 5 The woman's heart-beat rate at different times. (See Question 3.)

What can go wrong with the heart?

There are many causes of heart disease. It can be:

- Lifestyle — stress, diet, smoking, etc.
- Hereditary — passed on
- Congenital — developed when the baby is still growing in the womb, for example, as a result of the mother getting German measles during pregnancy.

It is possible to decrease the risk of heart disease by having a healthy lifestyle. This means taking plenty of exercise, eating a healthy low-fat diet, avoiding getting overweight, and not smoking.

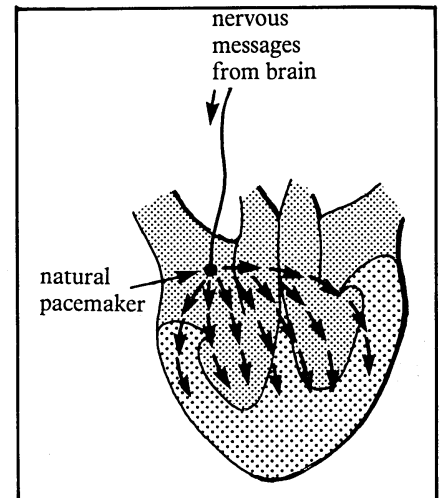

Figure 4 Electrical impulses passing through the heart from the natural pacemaker

Questions

- 1 Which ventricle sends blood to the lungs? Which sends it to the body?
- 2 Why does the pacemaker send electrical impulses to the atria before the ventricles?
- 3 A woman's heart-beat rate was measured at different times. The results are shown in Figure 5.
 - (a) What was: (i) the slowest rate; (ii) the fastest rate?
 - (b) What might have caused the heart-beat rate to increase?
 - (c) How long did it take before the heart-beat returned from the maximum rate to its original level?
- 4 Look again at the graph in Figure 1. What percentage of people survive for two years after having a pacemaker fitted?

The electrical activity in the heart can be recorded on a machine called an **electrocardiogram (ECG)**. This shows a trace on a screen or a sheet of paper. A typical trace is shown in Figure 6. A doctor can look at an ECG and tell whether a patient has problems with his or her heart.

When are pacemakers used?

Pacemakers can be used to treat several different heart disorders. For example:

- *Heart block* — when the electrical impulses do not pass properly along conduction pathways from the atria down to the ventricles.
- *Failure of the heart's own natural pacemaker* to function properly.
- *In some heart attacks* — when the blood supply to part of the heart muscle is cut off. This is usually because of a blockage in the coronary artery, and it may prevent electrical impulses being carried efficiently.

How does a pacemaker work?

The pacemaker supplies properly timed electric impulses to the heart muscle. This keeps the heart beating at the proper rate. It is rather like touching an electric wire to a muscle to make it contract. Electric impulses from the pacemaker travel down a wire lead to an electrode touching the heart wall

It is quite easy to build a simple electronic circuit to provide pulses of current. If you are interested, ask your teacher for a circuit diagram.

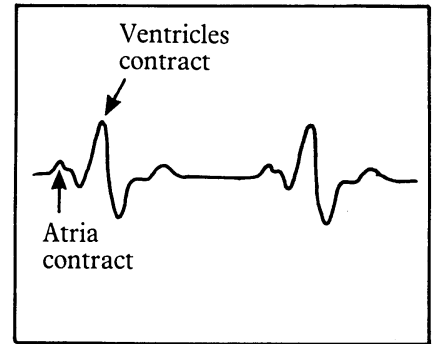

Figure 6 An ECG trace

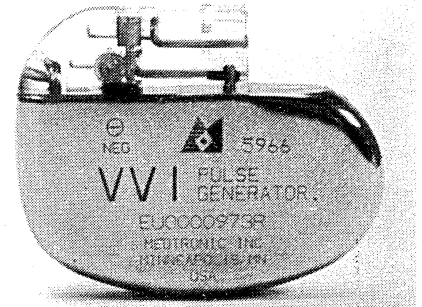

Figure 7 A heart pacemaker

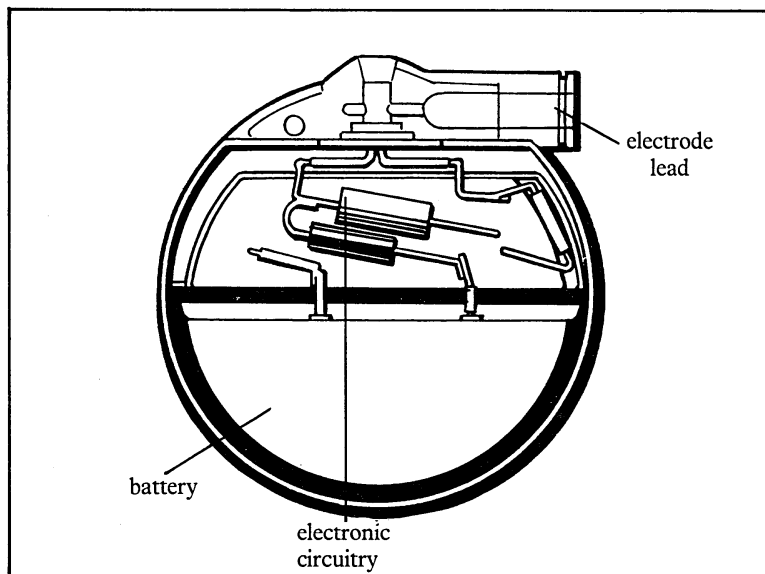

Figure 8 The main parts of a heart pacemaker unit

Fitting a pacemaker

A small cut is made and one of the large veins is exposed. The lead is then passed down inside the vein into the inside of the heart (Figure 9).

The tip of the electrode is lodged firmly at the bottom of the right ventricle, touching the muscle.

The pacemaker unit is placed under the skin of the upper chest.

The whole operation can take as little as 20 minutes to complete. It is carried out using a local anaesthetic.

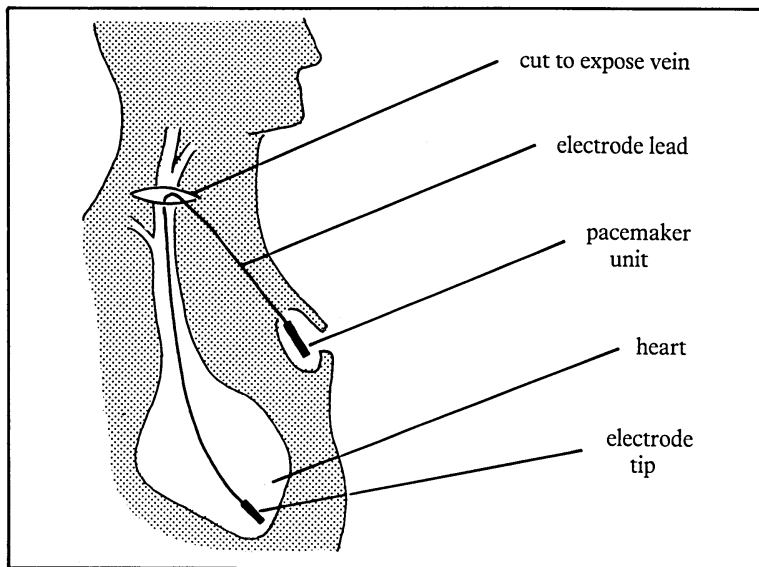

Figure 9 How a pacemaker is fitted

Questions to answer and discuss

These questions are best tackled in small groups of three or four.

- 5 Why do you think the pacemaker unit is fitted on the front of the chest, and not inside the chest, nearer the heart itself?
- 6 Why is the electrode lead passed down a vein, not an artery?
- 7 What do you think Bill Wheat's life would be like without a pacemaker?
- 8 Imagine you have a serious heart condition. What things would you be unable to do? How would it affect your general lifestyle?
- 9 An expert has suggested that the causes of heart disease are:

Lifestyle (stress, diet, smoking, etc.)	55%
Congenital (develops before baby is born)	3%
Other	42%

In other words, a lot of heart disease could be avoided by more healthy living.

It costs a lot of money to run a heart disease unit in a hospital. Do you think this is justified, given that the major cause of heart disease is people's own lifestyle?

- 10 Heart pacemakers are an example of the way modern technology can make a major contribution to medicine. What other examples can you think of?